

# UNIMIG



# VIPER

## MULTI135

---

<b>1. Safety</b>	<b>3</b>
<b>2. Machine Features</b>	<b>7</b>
<b>3. Machine Specifications</b>	<b>8</b>
3.1 Technical Data	8
3.2 MIG Specifications	8
3.3 TIG Specifications	8
3.4 STICK Specifications	8
3.5 Size & Weight	8
<b>4. Machine Layout</b>	<b>9</b>
4.1 Front Panel Layout	9
4.2 Rear Panel Layout	9
4.3 Interior Layout	10
<b>5. Package Contents</b>	<b>11</b>
<b>6. MIG: Machine Setup (Gasless)</b>	<b>12</b>
<b>7. MIG: Machine Setup (Gas-Shielded)</b>	<b>17</b>
<b>8. MIG: Welding Guide</b>	<b>23</b>
<b>9. MMA: Machine Setup</b>	<b>28</b>
<b>10. MMA: Welding Guide</b>	<b>31</b>
<b>11. TIG: Machine Setup</b>	<b>33</b>
<b>12. TIG: Welding Guide</b>	<b>37</b>
<b>13. Drive Roller Selection</b>	<b>41</b>
<b>14. MIG Torch Consumables</b>	<b>42</b>
<b>15. MIG Troubleshooting</b>	<b>43</b>
<b>16. TIG Troubleshooting</b>	<b>45</b>
<b>17. MMA (STICK) Troubleshooting</b>	<b>47</b>

# 1. Safety

Welding and cutting equipment can be dangerous to both the operator and people in or near the surrounding working area if the equipment is not correctly operated. Equipment must only be used under the strict and comprehensive observance of all relevant safety regulations.

**Read and understand this instruction manual carefully before the installation and operation of this equipment.**

## Machine operating safety

- Do not switch the function modes while the machine is operating. Switching of the function modes during welding can damage the machine. Damage caused in this manner will not be covered under warranty.
- Disconnect the electrode-holder cable from the machine before switching on the machine, to avoid arcing should the electrode be in contact with the workpiece.
- Operators should be trained and or qualified.



## Electric shock: it can kill

- Touching live electrical parts can cause fatal shocks or severe burns. The electrode and work circuit is electrically live whenever the output is on. The input power circuit and internal machine circuits are also live when power is on. In MIG/MAG welding, the wire, drive rollers, wire feed housing, and all metal parts touching the welding wire are electrically live. Incorrectly installed or improperly grounded equipment is dangerous.
- Connect the primary input cable, according to Australian and New Zealand standards and regulations.
- Avoid all contact with live electrical parts of the welding/cutting circuit, electrodes and wires with bare hands.
- The operator must wear dry welding gloves while he/she performs the welding/cutting task.
- The operator should keep the workpiece insulated from himself/herself.
- Keep cords dry, free of oil and grease, and protected from hot metal and sparks.
- Frequently inspect input power cable for wear and tear, replace the cable immediately if damaged, bare wiring is dangerous and can kill.
- Do not use damaged, undersized, or badly joined cables.
- Do not drape cables over your body.
- We recommend (RCD) safety switch is used with this equipment to detect any leakage of current to earth.



## Fumes and gases are dangerous

- Smoke and gas generated while welding or cutting can be harmful to people's health. Welding produces fumes and gases. Breathing these fumes and gases can be hazardous to your health.
- Do not breathe the smoke and gas generated while welding or cutting, keep your head out of the fumes.
- Keep the working area well ventilated, use fume extraction or ventilation to remove welding/cutting fumes and gases.
- In confined or heavy fume environments always wear an approved air-supplied respirator.
- Welding/cutting fumes and gases can displace air and lower the oxygen level, causing injury or death. Be sure the breathing air is safe.
- Do not weld/cut in locations near degreasing, cleaning, or spraying operations. The heat and rays of the arc can react with vapours to form highly toxic and irritating gases.
- Materials such as galvanised, lead, or cadmium plated steel, containing elements that can give off toxic fumes when welded/cut. Do not weld/cut these materials unless the area is very well ventilated, and or wearing an air-supplied respirator.



## Arc rays: harmful to people's eyes and skin

- Arc rays from the welding/cutting process produce intense visible and invisible ultraviolet and infrared rays that can burn eyes and skin.
- Always wear a welding helmet with the correct shade of filter lens and suitable protective clothing, including welding gloves while the welding/cutting operation is performed.
- Measures should be taken to protect people in or near the surrounding working area. Use protective screens or barriers to protect others from flash, glare and sparks; warn others not to watch the arc.



## Fire hazard

- Welding/cutting on closed containers, such as tanks, drums, or pipes, can cause them to explode. Flying sparks from the welding/cutting arc, hot workpiece, and hot equipment can cause fires and burns. Accidental contact of the electrode to metal objects can cause sparks, explosion, overheating, or fire. Check and be sure the area is safe before doing any welding/cutting.
- The welding/cutting sparks & spatter may cause fire, therefore remove any flammable materials well away from the working area. Cover flammable materials and containers with approved covers if unable to be moved from the welding/cutting area.
- Do not weld/cut on closed containers such as tanks, drums, or pipes, unless they are correctly prepared according to the required Safety Standards to ensure that flammable or toxic vapours and substances are totally removed, these can cause an explosion even though the vessel has been “cleaned”. Vent hollow castings or containers before heating, cutting or welding. They may explode.
- Do not weld/cut where the atmosphere may contain flammable dust, gas, or liquid vapours (such as petrol)
- Have a fire extinguisher nearby and know how to use it. Be alert that welding/cutting sparks and hot materials from welding/cutting can easily go through small cracks and openings to adjacent areas. Be aware that welding/cutting on a ceiling, floor, bulkhead, or partition can cause a fire on the hidden side.

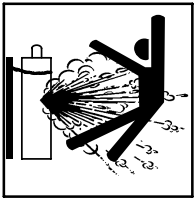

## Gas cylinders

- Shielding gas cylinders contain gas under high pressure. If damaged, a cylinder can explode. Because gas cylinders usually are part of the welding/cutting process, be sure to treat them carefully. CYLINDERS can explode if damaged.
- Protect gas cylinders from excessive heat, mechanical shocks, physical damage, slag, open flames, sparks, and arcs.
- Ensure cylinders are held secure and upright to prevent tipping or falling over.
- Never allow the welding/cutting electrode or earth clamp to touch the gas cylinder, do not drape welding cables over the cylinder.
- Never weld/cut on a pressurised gas cylinder, it will explode and kill you.
- Open the cylinder valve slowly and turn your face away from the cylinder outlet valve and gas regulator.



## Gas build-up

- The build-up of gas can cause a toxic environment, deplete the oxygen content in the air resulting in death or injury. Many gases use in welding/cutting are invisible and odourless.
- Shut off shielding gas supply when not in use.
- Always ventilate confined spaces or use approved air-supplied respirator.

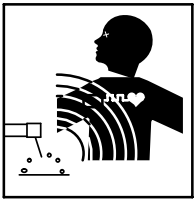

## Electronic magnetic fields

- MAGNETIC FIELDS can affect Implanted Medical Devices.
- Wearers of Pacemakers and other Implanted Medical Devices should keep away.
- Implanted Medical Device wearers should consult their doctor and the device manufacturer before going near any electric welding, cutting or heating operation.



## Noise can damage hearing

- Noise from some processes or equipment can damage hearing.
- Wear approved ear protection if noise level is high.



## Hot parts

- Items being welded/cut generate and hold high heat and can cause severe burns.
- Do not touch hot parts with bare hands. Allow a cooling period before working on the welding/cutting gun. Use insulated welding gloves and clothing to handle hot parts and prevent burns.

# Caution

## Working environment

- The environment in which this welding/cutting equipment is installed must be free of grinding dust, corrosive chemicals, flammable gas or materials etc., and at no more than a maximum of 80% humidity.
- When using the machine outdoors, protect the machine from direct sunlight, rainwater and snow, etc.; the temperature of the working environment should be maintained within -10°C to +40°C.
- Keep this equipment 30cm distant from the wall.
- Ensure the working environment is well ventilated.

## Safety tips

- **Ventilation:** This equipment is small-sized, compact in structure, and of excellent performance in amperage output. The fan is used to dissipate heat generated by this equipment during the welding/cutting operation. Important: Maintain good ventilation of the louvres of this equipment. The minimum distance between this equipment and any other objects in or near the working area should be 30 cm. Good ventilation is of critical importance for the normal performance and service life of this equipment.
- **Thermal Overload Protection:** Should the machine be used to an excessive level, or in a high-temperature environment, poorly ventilated area or if the fan malfunctions the Thermal Overload Switch will be activated, and the machine will cease to operate. Under this circumstance, leave the machine switched on to keep the built-in fan working to bring down the temperature inside the equipment. The machine will be ready for use again when the internal temperature reaches a safe level.
- **Over-Voltage Supply:** Regarding the power supply voltage range of the machine, please refer to the “Main parameter” table. This equipment is of automatic voltage compensation, which enables the maintaining of the voltage range within the given range. In case that the voltage of input power supply amperage exceeds the stipulated value, it is possible to cause damage to the components of this equipment. Please ensure your primary power supply is correct.
- Do not come into contact with the output terminals while the machine is in operation. An electric shock may occur.

# Maintenance

Exposure to extremely dusty, damp, or corrosive air is damaging to the welding/cutting machine. To prevent any possible failure or fault of this welding/cutting equipment, clean the dust at regular intervals with clean and dry compressed air of required pressure.

**Please note that:** lack of maintenance can result in the cancellation of the guarantee; the guarantee of this welding/cutting equipment will be void if the machine has been modified, attempt to take apart the machine or open the factory-made sealing of the machine without the consent of an authorized representative of the manufacturer.

# Troubleshooting

**Caution:** Only qualified technicians are authorized to undertake the repair of this welding/cutting equipment. For your safety and to avoid Electrical Shock, please observe all safety notes and precautions detailed in this manual.

## **Attention! - Check For Gas Leakage**

At initial set up and at regular intervals we recommend to check for gas leakage

Recommended procedure is as follows:

- 1.** Connect the regulator and gas hose assembly and tighten all connectors and clamps.
- 2.** Slowly open the cylinder valve.
- 3.** Set the flow rate on the regulator to approximately 8-10 L/min.
- 4.** Close the cylinder valve and pay attention to the needle indicator of the contents pressure gauge on the regulator, if the needle drops away towards zero there is a gas leak. Sometimes a gas leak can be slow and to identify it will require leaving the gas pressure in the regulator and line for an extended time period. In this situation it is recommended to open the cylinder valve, set the flow rate to 8-10 L/min, close the cylinder valve and check after a minimum of 15 minutes.
- 5.** If there is a gas loss then check all connectors and clamps for leakage by brushing or spraying with soapy water, bubbles will appear at the leakage point.
- 6.** Tighten clamps or fittings to eliminate gas leakage.

**IMPORTANT! - We strongly recommend that you check for gas leakage prior to operation of your machine. We recommend that you close the cylinder valve when the machine is not in use.**

**Welding Guns Of Australia PTY LTD, authorised representatives or agents of Welding Guns Of Australia PTY LTD will not be liable or responsible for the loss of any gas.**

## 2. Machine Features

### VIPER MULTI 135



#### **Synergic MIG Control**

The clever Synergic MIG control takes the guesswork out of your settings. Simply select your wire size and adjust the Synergic power knob to the thickness of your material. The program works with 0.6, 0.8 and 0.9mm mild steel, stainless steel & flux-cored wires.

#### **Gas & Gasless MIG**

This machine supports both gas-shielded MIG and gasless MIG wire, meaning you can easily run mild steel, stainless steel & flux-cored MIG wire.

#### **Multi-Process Welding**

This three-in-one machine lets you perform MIG, TIG and STICK welding all on one machine. There is no need to swap between machines, saving you time and setup.

#### **10A Plug**

A 10 AMP power plug can be used on any domestic outlet. It's perfect for the DIY home handyman or the professional welder looking for a machine that can be used almost anywhere.

#### **Lightweight & Portable**

Weighing just over 5kg, the VIPER MULTI 135 SYNERGIC is ready to go anywhere you need it. Also included is a shoulder strap for extra comfort and portability.

## 3. Machine Specifications

### VIPER MULTI 135

#### 3.1 Technical Data

Parameter	Values
SKU	U11005K
Primary Input Voltage	240V Single Phase
Supply Plug	10 AMP
I <sub>eff</sub> (A)	8.4
Rated Output	40/16V-135A/21V
No Load Voltage (V)	68
Protection Class	IP21S
Insulation Class	H
Minimum Generator (kVA)	8.0
Dinse Connector	10/25
Standard	AS/NZ60974-1
Welds	Mild Steel, Stainless Steel, Cast Iron, Silicon Bronze, Copper
Warranty (Years)	2

#### 3.2 MIG Specifications

Parameter	Values
MIG Welding Current Range	40-135A
MIG Duty Cycle @ 40°C	15% @ 135A 60% @ 65A 100% @ 50A
MIG Wire Size Range	0.6-0.9mm
MIG Wire Spool Size	1kg
MIG Welding Thickness Range	1-6mm

#### 3.3 TIG Specifications

Parameter	Values
TIG Function Type	DC Lift Arc
TIG Welding Current Range	20-120A
TIG Duty Cycle @ 40°C	15% @ 120A 60% @ 60A 100% @ 45A
TIG Welding Thickness Range	1-6mm

#### 3.4 STICK Specifications

Parameter	Values
STICK Welding Current Range	20-120A
STICK Duty Cycle @ 40°C	15% @ 120A 60% @ 60A 100% @ 45A
STICK Electrode Range	2.5-3.2mm
STICK Welding Thickness Range	3-6mm

#### 3.5 Size & Weight

Parameter	Values
Dimensions (mm)	353x132x250mm
Weight (kg)	5.2kg



## 4. Machine Layout

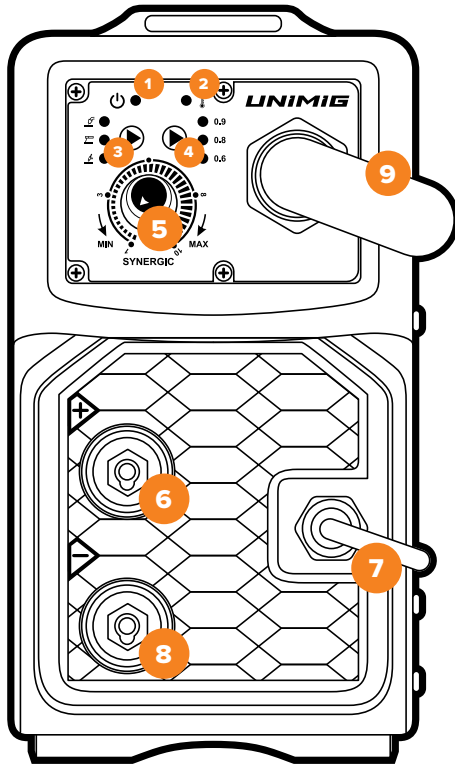

### 4.1 Front Panel Layout

1. Power LED
2. Thermal Overload LED
3. Weld Mode Selector
4. Synergic MIG Programs
5. Synergic Control Knob
6. Positive Output (+)
7. Polarity Cable
8. Negative Output (-)
9. Direct Connect MIG Torch

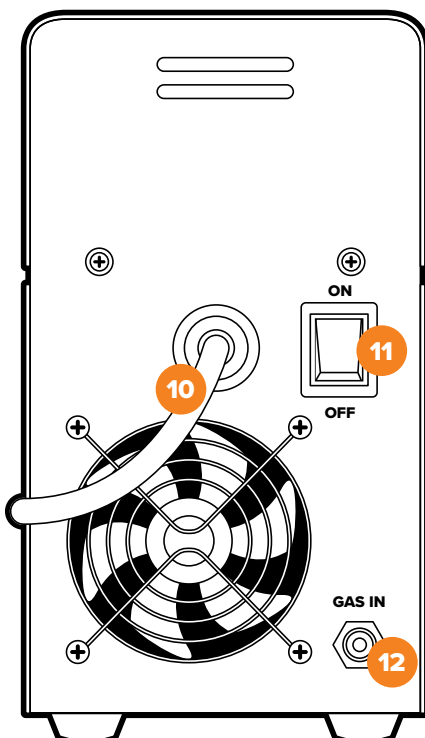

### 4.2 Rear Panel Layout

10. Power Cable
11. Power Switch
12. Gas Inlet

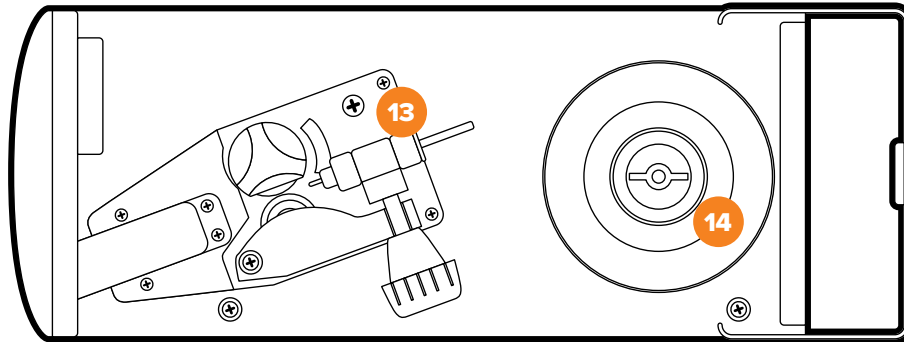

### 4.3 Interior Layout

13. Wire Spool Holder

14. Wire Feed Assembly

## 5. Package Contents

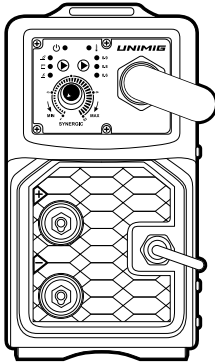

**VIPER MULTI 135**

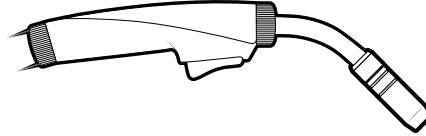

**2m Direct Connect MIG Torch**

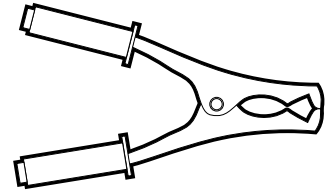

**2m Earth Clamp & Lead**

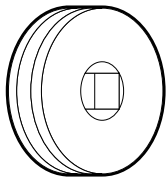

1 x 0.6-0.8mm "V GROOVE" 25/9 - SOLID WIRE  
1 x 0.8-0.9mm "F GROOVE" 25/9 - GASLESS WIRE

**Drive Rollers**

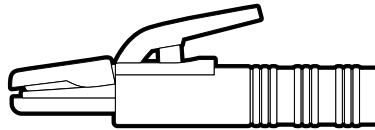

**Electrode Holder**

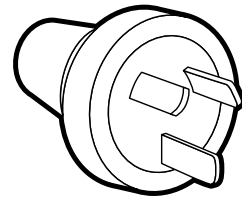

**10A Plug (Fitted)**

## 6. MIG: Machine Setup (Gasless)

1. Connect the polarity cable to the **negative (-)** dinse connection, twist to lock in place.
2. Connect the earth clamp to the **positive (+)** dinse connection, twist to lock in place.

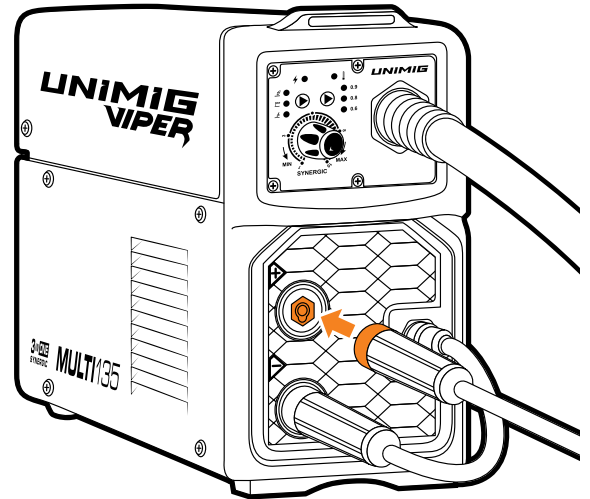
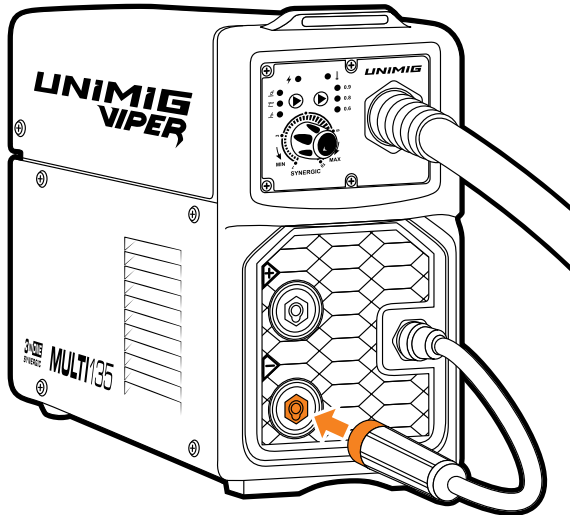

3. Connect the plug into a 10 AMP socket, then switch the machine ON.
4. Pull up the roller tension knob to release the wire drive.

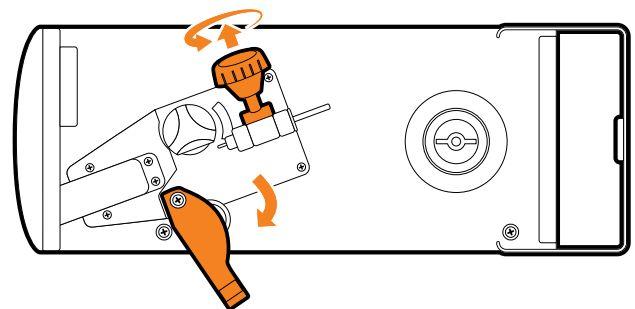
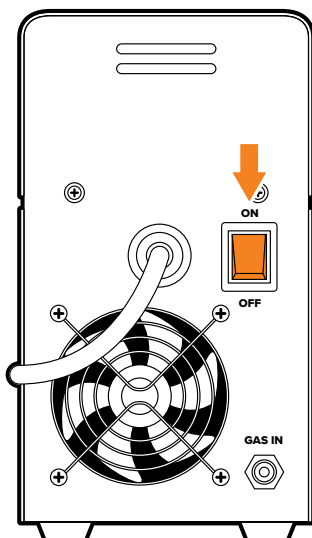

5. Unscrew the roller cap.

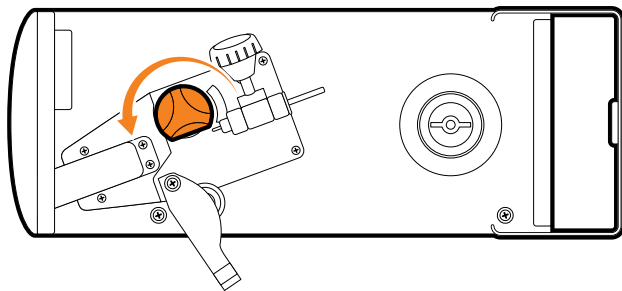

6. Ensure you have a Knurled (F Groove) drive roller installed. If not, fit correct roller and replace the roller cover.

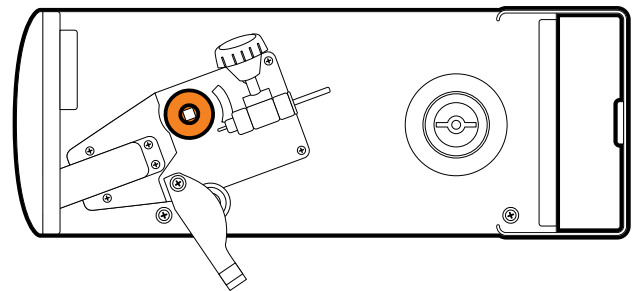

7. Unscrew spool retaining nut and remove tension spring and spool holder bracket.

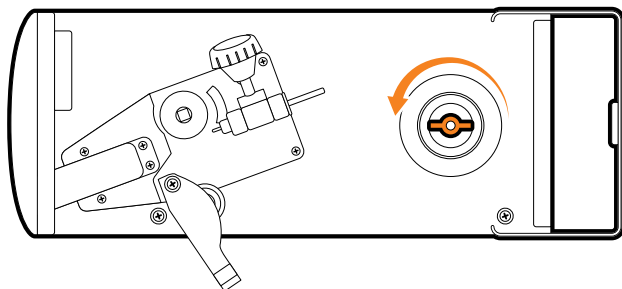

8. Place 1kg wire spool onto the spool holder.

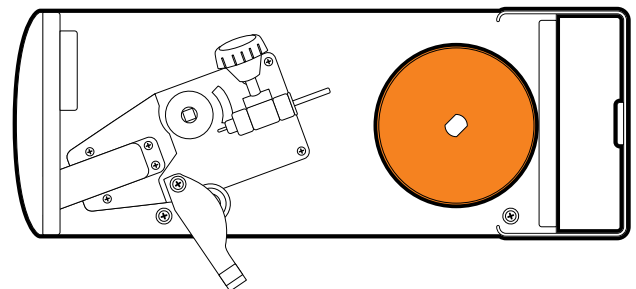

- 9.** Replace tension spring and spool holder bracket, then tighten spool retaining nut.

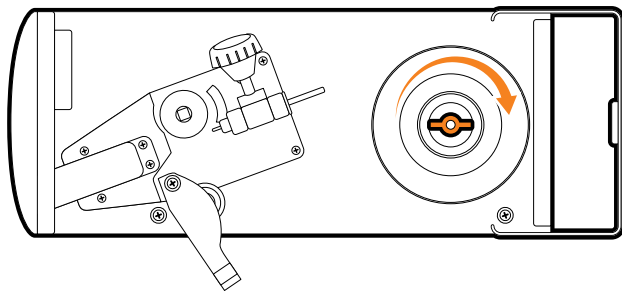

- 10.** Feed wire through the inlet guide tube to the outlet guide tube. Ensure that the wire passes through the roller.

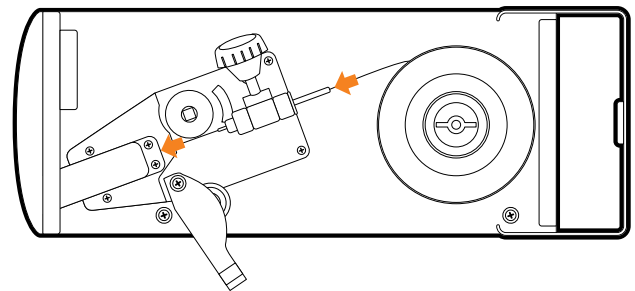

- 11.** Pull down tension knob to lock wire in place. Twist to tighten.

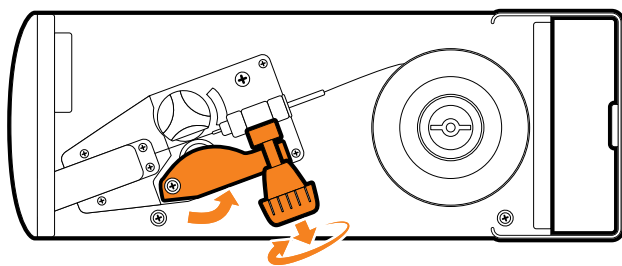

- 12.** Select MIG from the weld mode selector.

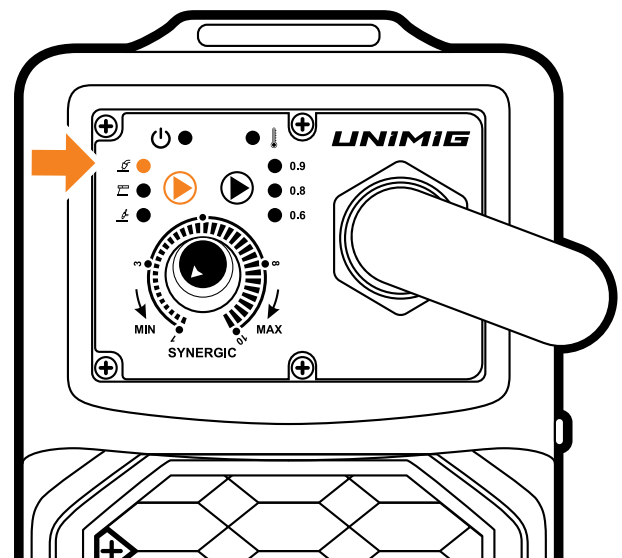

**13.** Remove front end consumables from the MIG torch.

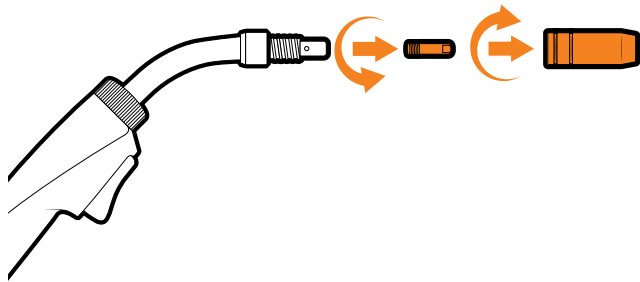

**14.** Hold down the torch trigger to feed wire through to the torch. If the wire slips or stops you will need to adjust the roller tension knob.

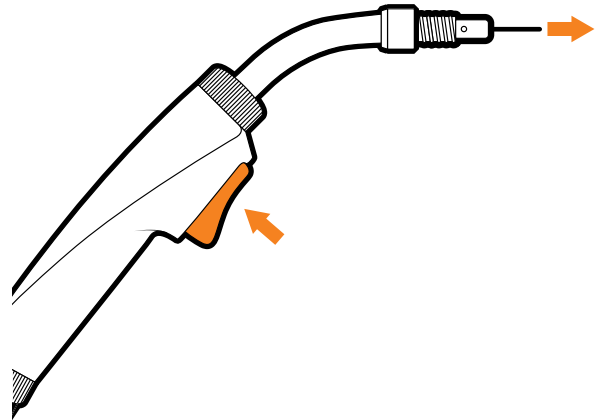

**15.** Replace front end consumables on the MIG torch.

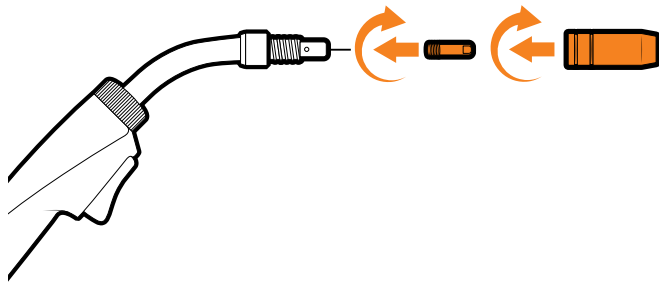

**16.** Select wire size according to the wire pool installed.

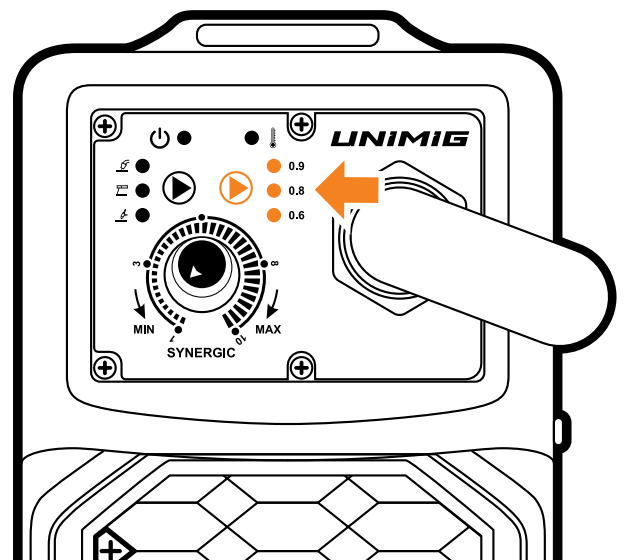

- 17.** Adjust synergic power knob according to material thickness. Use a higher value for thicker material, and a lower value for thinner material.

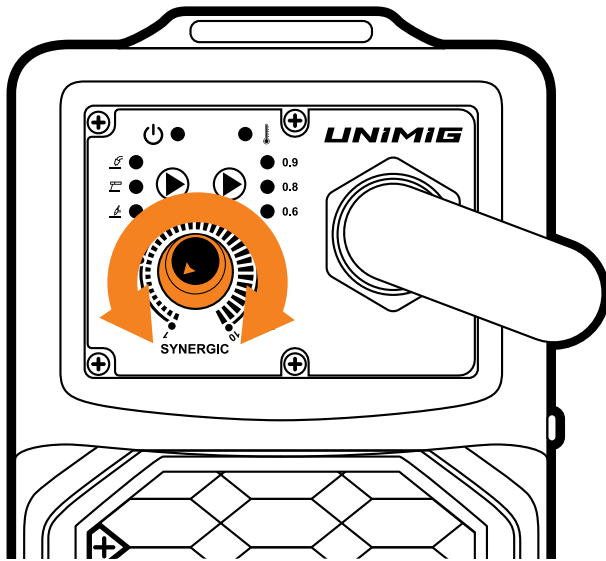

- 18.** Connect earth clamp to your workpiece.

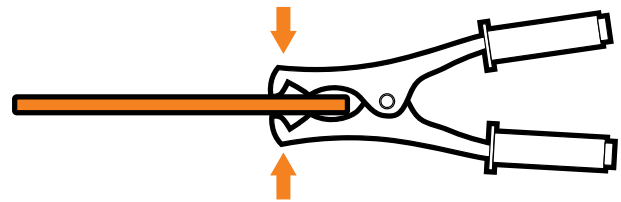

- 19.** Line up the torch with your workpiece, then simply pull the trigger to initiate the weld. For gasless MIG, the drag method is recommended for optimum weld quality. Release trigger to end the weld.

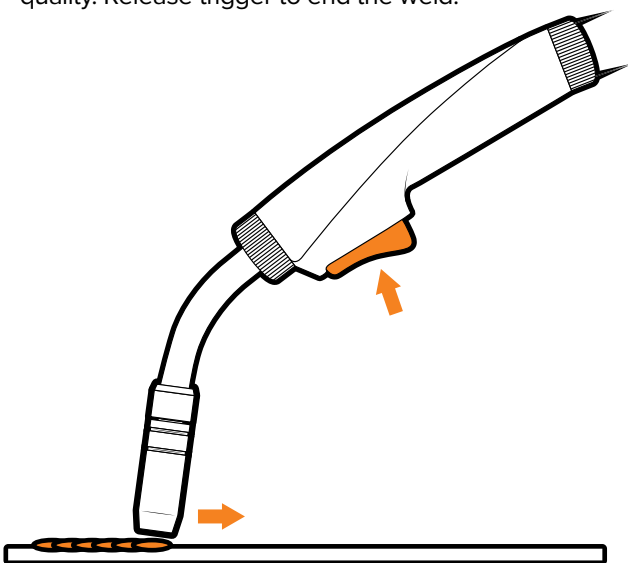



## 7. MIG: Machine Setup (Gas-Shielded)

1. Connect the polarity cable to the **positive (+)** dinse connection, twist to lock in place.
2. Connect the earth clamp to the **negative (-)** dinse connection, twist to lock in place.

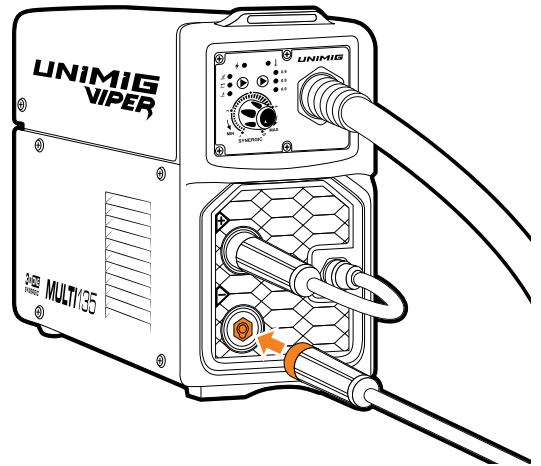
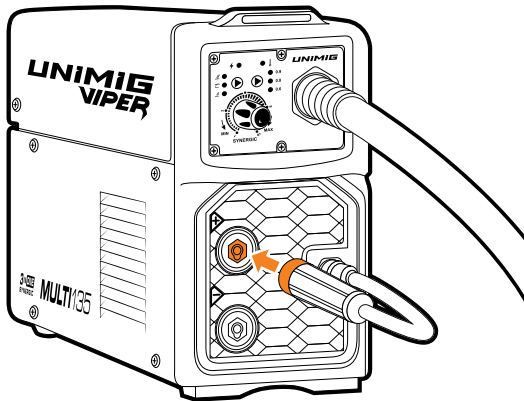

3. Connect the plug into a 10 AMP power point, then switch the machine ON.
4. Pull up the roller tension knob to release the wire drive.

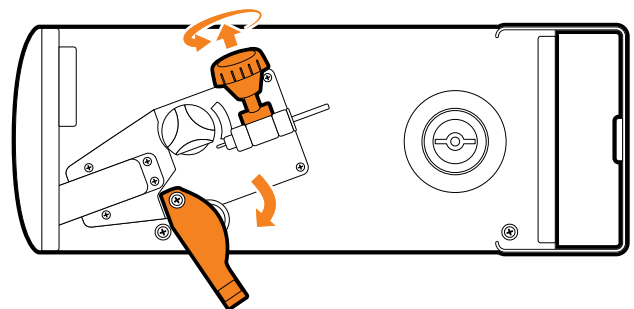
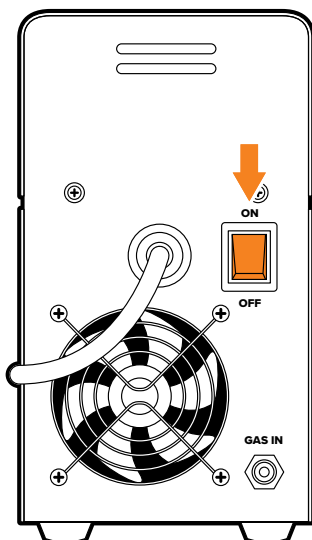

5. Unscrew the roller cap.

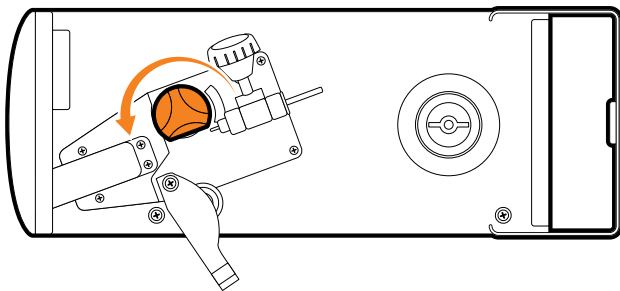

6. Ensure you have a V Groove drive roller installed. If not, fit correct roller and replace the roller cover.

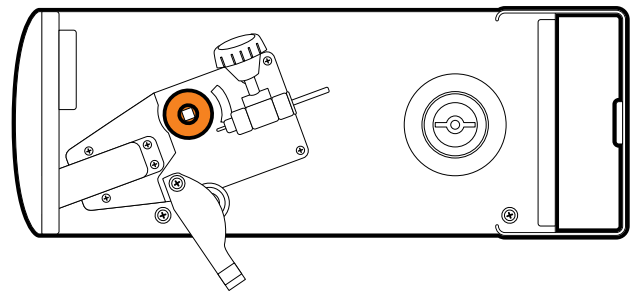

7. Unscrew spool retaining nut and remove tension spring and spool holder bracket.

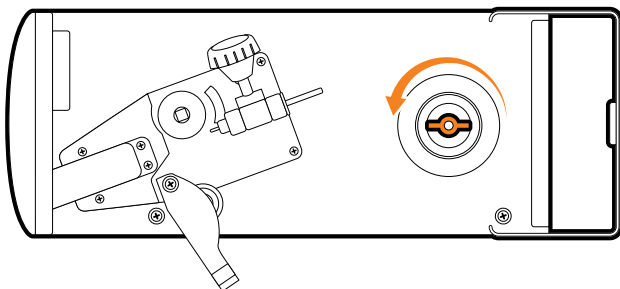

8. Place 1kg wire spool onto the spool holder.

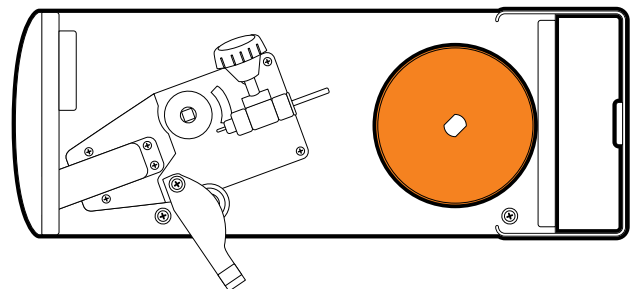

- 9.** Replace tension spring and spool holder bracket, then tighten spool retaining nut.

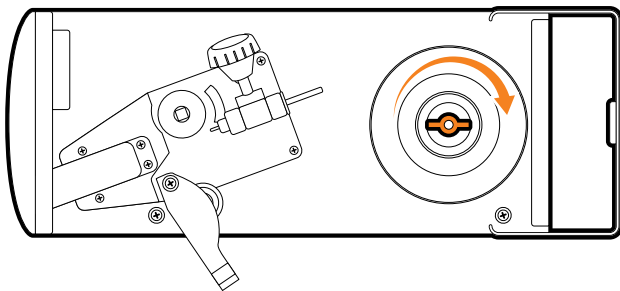

- 10.** Feed wire through the inlet guide tube to the outlet guide tube. Ensure that the wire passes through the roller.

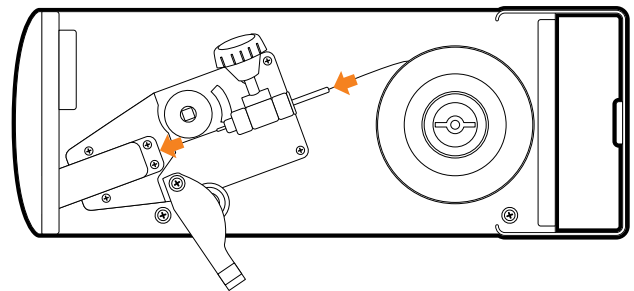

- 11.** Pull down tension knob to lock wire in place. Twist to tighten.

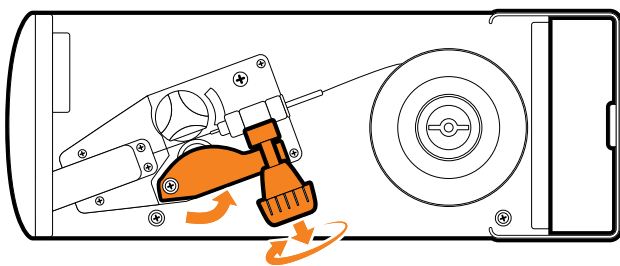

- 12.** Select MIG from the weld mode selector.

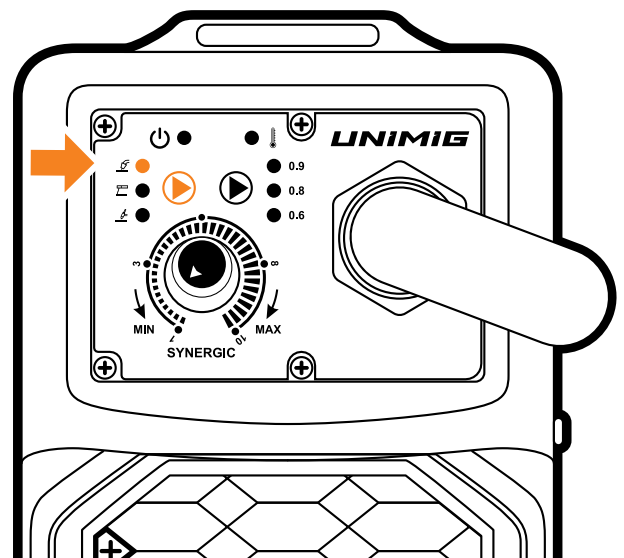

**13.** Remove front end consumables from the MIG torch.

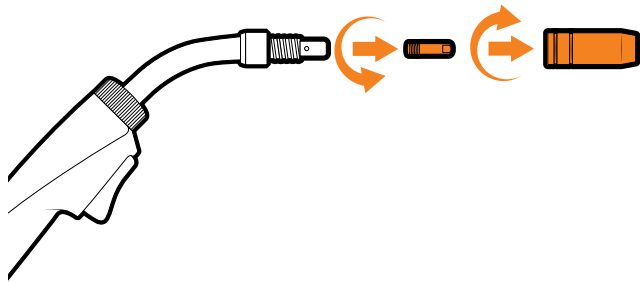

**14.** Hold down the torch trigger to feed wire through to the torch. If the wire slips or stops you will need to adjust the roller tension knob.

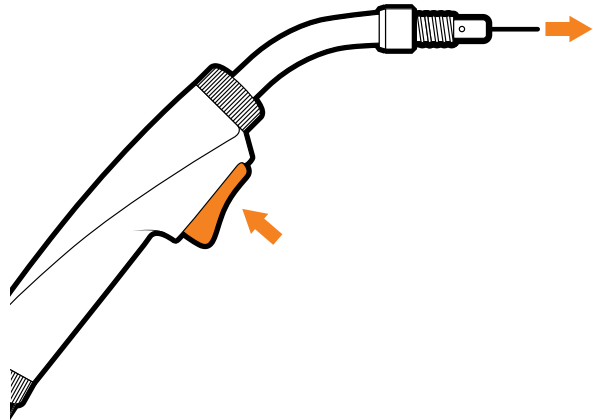

**15.** Replace front end consumables on the MIG torch.

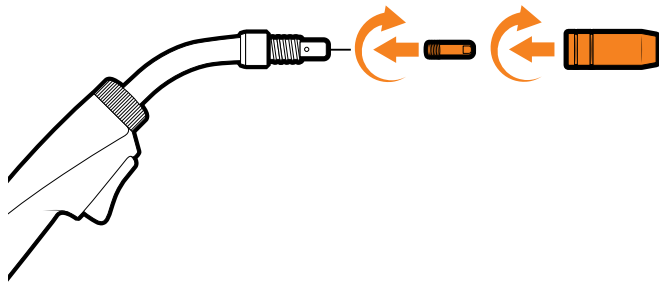

**16.** Place twin gauge argon regulator into your gas outlet.

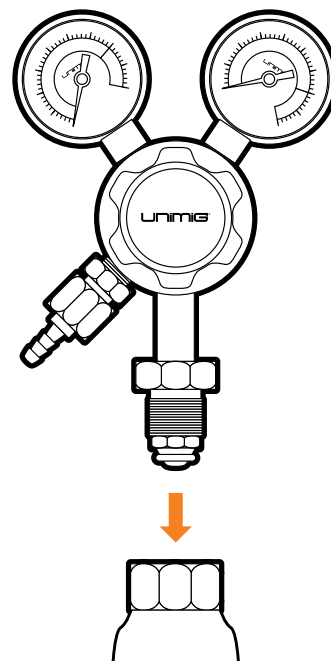

**17.** Tighten securely with wrench.

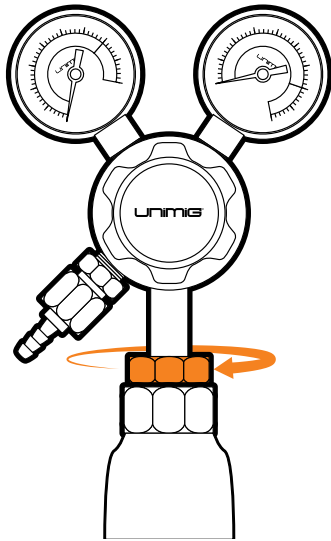

**18.** Connect gas hose to the regulator outlet, and crimp in place.

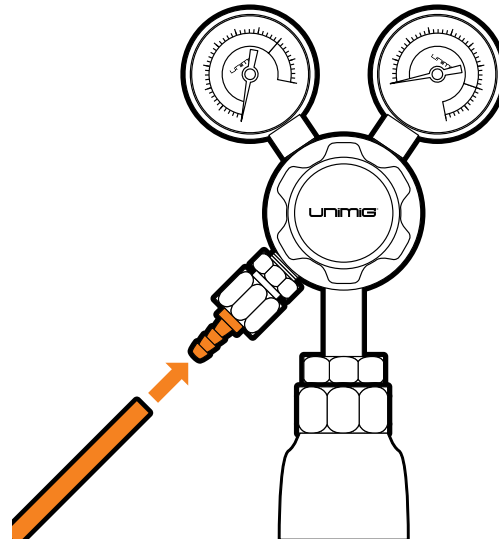

**19.** Connect gas hose to the gas inlet on the rear of the machine.

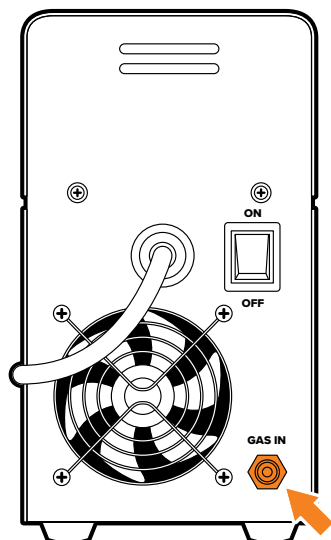

**20.** Adjust gas flow to 8-12L/min.

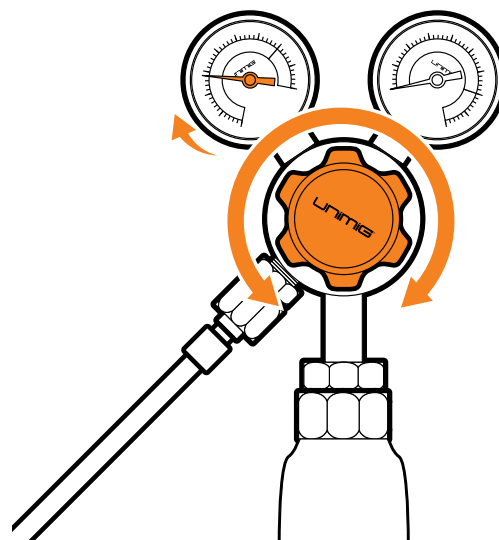

**21.** Select wire size according to the wire spool installed.

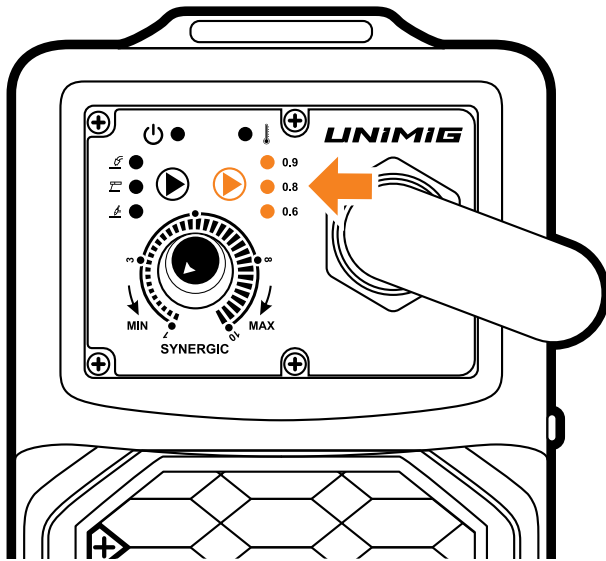

**22.** Adjust synergic power knob according to material thickness. Use a higher value for thicker material, and a lower value for thinner material.

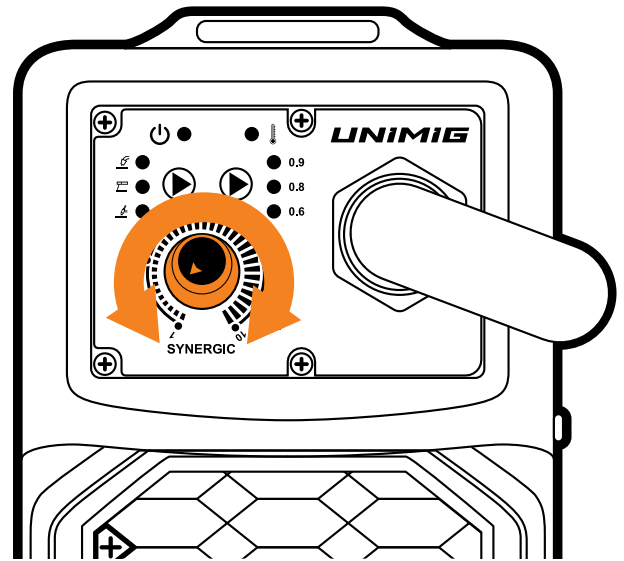

**23.** Connect earth clamp to your workpiece.

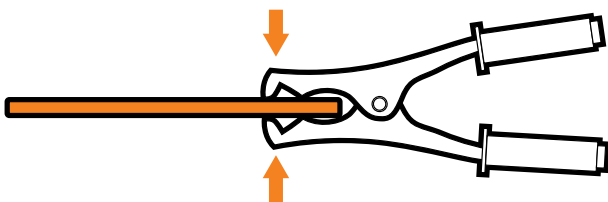

**24.** Line up the torch with your workpiece, then simply pull the trigger to initiate the weld. For gas-shielded MIG, the push method is recommended for optimum weld quality. Release trigger to end the weld.

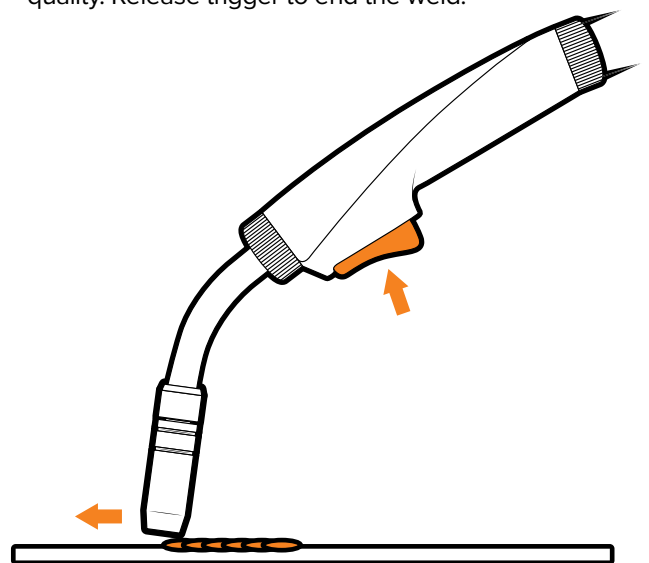

## 8. MIG: Welding Guide

### 8.1 MIG (Metal Inert Gas) Welding

MIG (Metal Inert Gas) welding, also known as GMAW (Gas Metal Arc Welding) or MAG (Metal Active Gas Welding), is a semi-automatic arc welding process in which a consumable wire electrode and a shielding gas are fed through a welding gun. A constant voltage and direct current power source is most commonly used with MIG welding.

There are four primary methods of metal transfer in MIG welding. Short circuit (also known as dip transfer), globular transfer, spray transfer and pulse spray, each of which has distinct properties and corresponding advantages and limitations. To perform MIG welding, the necessary equipment is a welding gun, a wire feed unit, a welding power supply, an electrode wire, and a shielding gas supply.

### 8.2 Short Circuit Transfer

Short circuit transfer is the most commonly used method whereby the wire electrode is fed continuously down the welding torch through to and exiting the contact tip. The wire touches the workpiece and causes a short circuit. The wire heats up and begins to form a molten bead, the bead separates from the end of the wire and forms a droplet that is transferred into the weld pool. This process is repeated about 100 times per second, making the arc appear constant to the human eye.

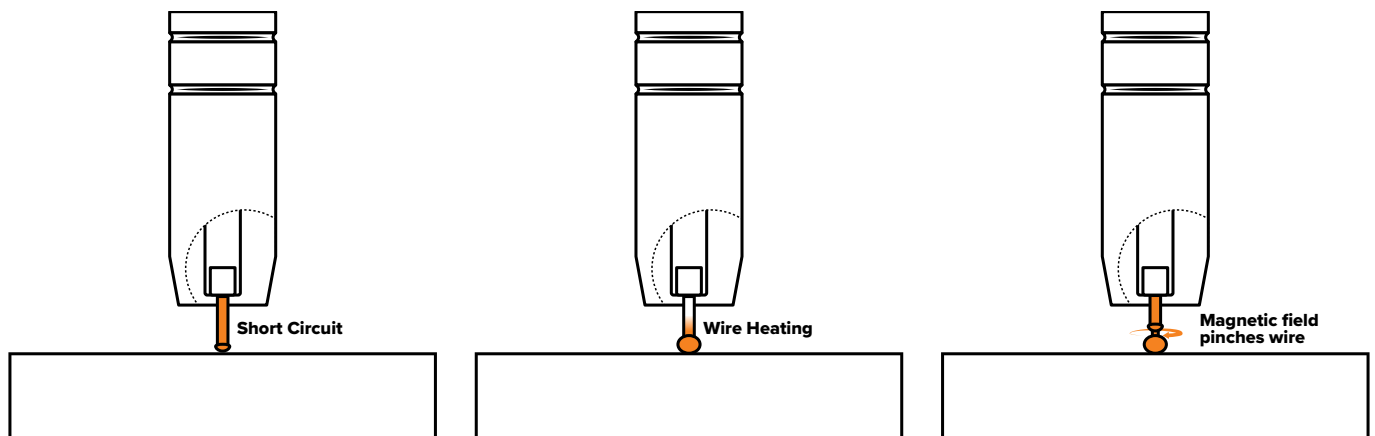

The wire approaches the workpiece and touches the work, creating a short circuit between the wire and the base metal, because there is no space between the wire and the base metal there is no arc and current flows through the wire.

The wire cannot support all the current flow, resistance builds up and the wire becomes hot and weak and begins to melt.

The current flow creates a magnetic field that begins to pinch the melting wire forming it into droplet.

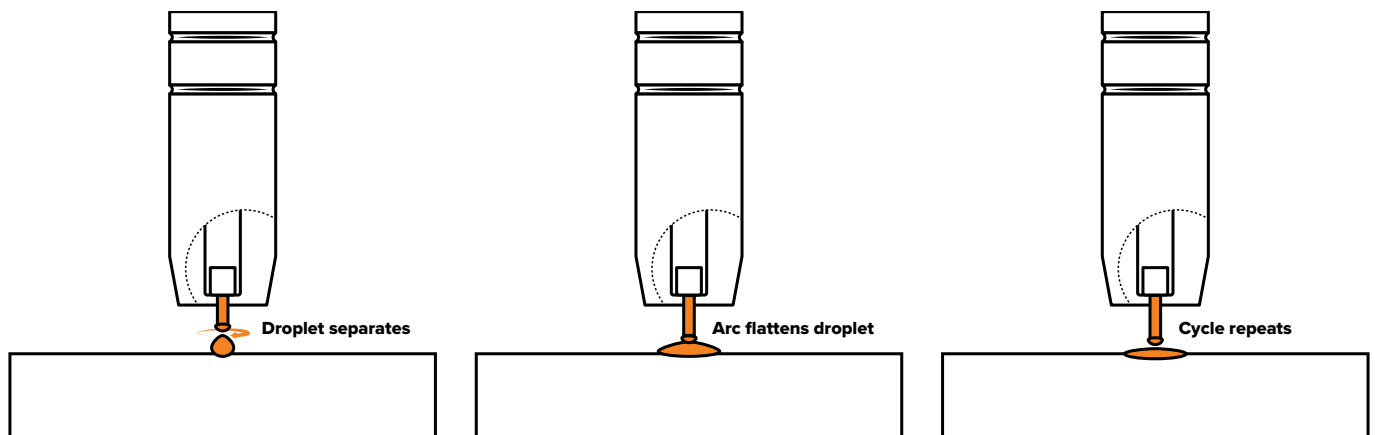

The pinch causes the forming droplet to separate and fall towards the forming weld pool.

An arc is created at the separation of the droplet and the heat and force of the arc flattens out the droplet into the weld pool. The heat of the arc melts the end of the wire slightly as it feeds towards the base metal.

The wire feed speed overcomes the heat of the arc and the wire again approaches the work to short circuit and repeat the cycle.

## 8.3 Basic MIG Welding

Good weld quality and weld profile depend on gun angle, the direction of travel, electrode extension (stick out), travel speed, the thickness of base metal, wire feed speed (amperage) and arc voltage. To follow are some basic guides to assist with your setup.

### 8.3.1 Gun Position - Travel Direction & Work Angle

Gun position or technique usually refers to how the wire is directed at the base metal, the angle and travel direction chosen. Travel speed and work angle will determine the characteristic of the weld bead profile and degree of weld penetration.

### 8.3.2 Push Technique

The wire is located at the leading edge of the weld pool and pushed towards the un-melted work surface. This technique offers a better view of the weld joint and direction of the wire into the weld joint. Push technique directs the heat away from the weld puddle, allowing faster travel speeds providing a flatter weld profile with light penetration - useful for welding thin materials. The welds are wider and flatter, allowing for minimal clean up / grinding time.

### 8.3.3 Perpendicular Technique

The wire is fed directly into the weld. This technique is used primarily for automated situations or when conditions make it necessary. The weld profile is generally higher, and deeper penetration is achieved.

### 8.3.4 Pull/Drag Technique

The gun and wire are dragged away from the weld bead. The arc and heat are concentrated on the weld pool. The base metal receives more heat, deeper melting, more penetration and the weld profile is higher with more buildup.

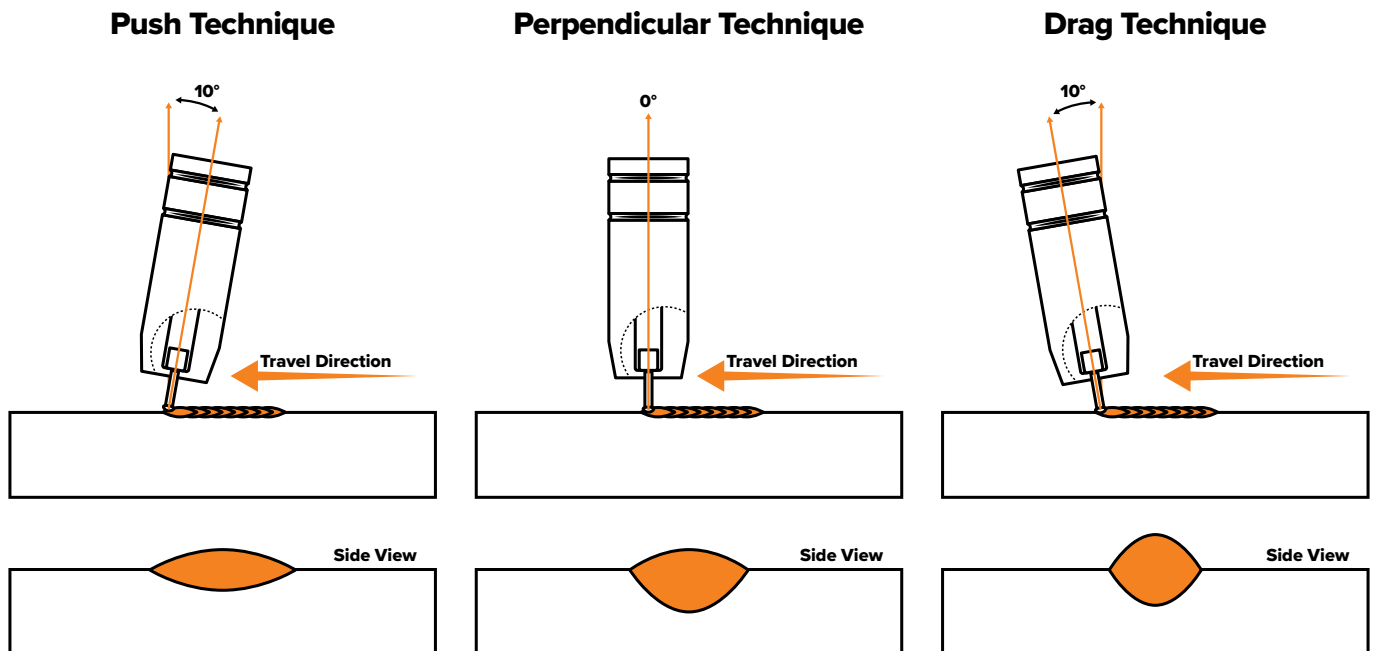

Flat, even weld profile, light penetration.

Narrower weld profile, even penetration.

Narrower and higher weld profile, more penetration.



## 8.4 Travel Angle

The travel angle is the right to left, relative to the direction of welding. A travel angle of 5°- 15° is ideal and produces the right level of control over the weld pool. A travel angle higher than 20° will give an unstable arc condition with poor weld metal transfer, less penetration, high levels of spatter, weak gas shielding and a poor quality finished weld.

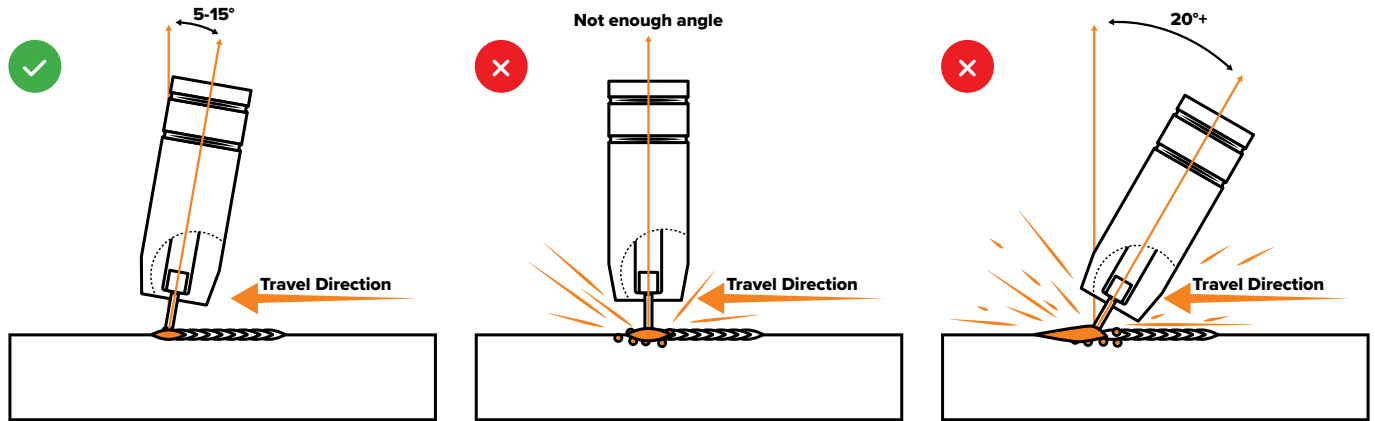

Good level of control over the weld pool, even flat weld.

Less control over the weld pool, more spatter.

Poor control, unstable arc, less penetration, lots of spatter.

## 8.5 Work Angle

The work angle is the up and down angle of the gun relative to the workpiece.

The correct work angle provides good bead shape, prevents undercut, uneven penetration, weak gas shielding and a poor quality finished weld.

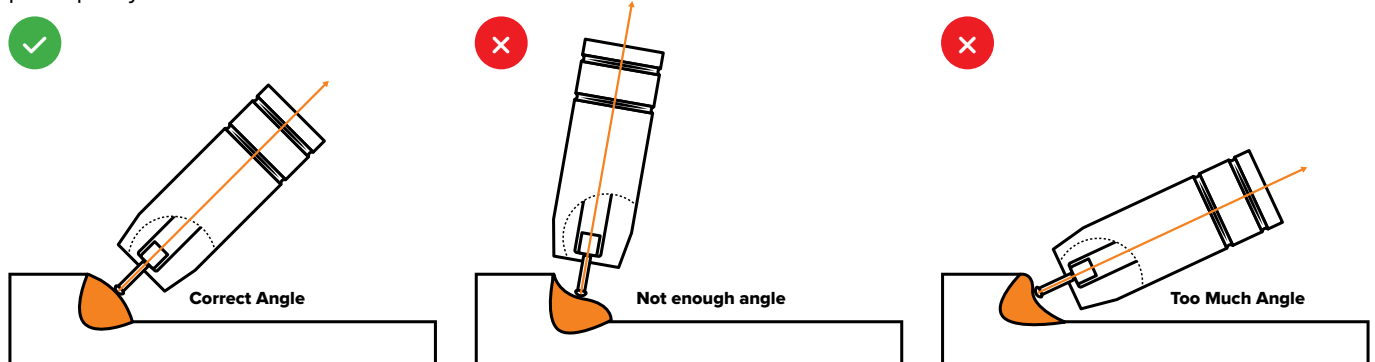

## 8.6 Stick Out

Stick out is the length of the unmelted wire protruding from the end of the contact tip.

A constant, even stick out of 5-10mm will produce a stable arc and an even current flow providing good penetration and even fusion. Too short a stick out will cause an unstable weld pool, produce spatter and overheat the contact tip. Too long stick out will cause an unstable arc, lack of penetration, lack of fusion, and increase spatter.

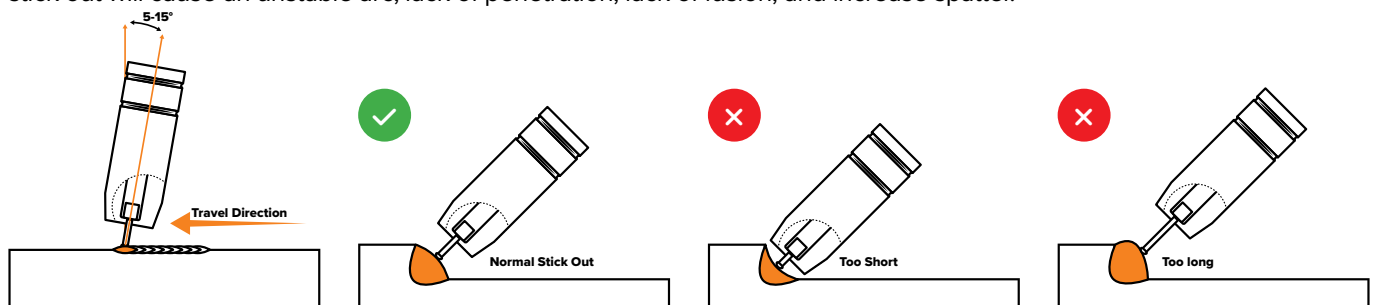

## 8.7 Travel Speed

Travel speed is the rate that the gun is moved along the weld joint and is usually measured in mm per minute. Travel speeds can vary depending on conditions and the welder's skill and is limited to the welder's ability to control the weld pool. Push technique allows faster travel speeds than Drag technique. The gas flow must also correspond with the travel speed, increasing with faster travel speed and decreasing at a slower speed. Travel speed needs to match the amperage and will decrease as the material thickness and amperage increase.

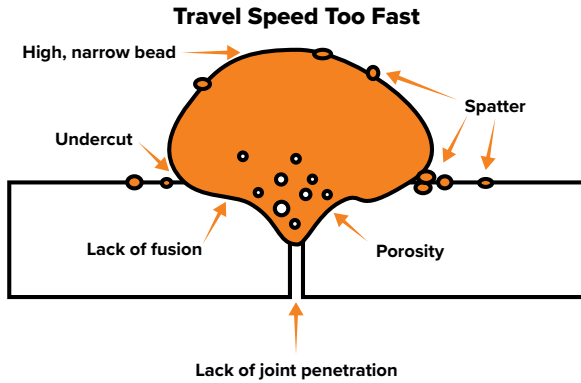

### 8.7.1 Travel Speed Too Fast

A too fast travel speed produces too little heat per mm of travel, resulting in less penetration and reduced weld fusion, the weld bead solidifies very quickly trapping gases inside the weld metal causing porosity. Undercutting of the base metal can also occur, and an unfilled groove in the base metal is created when the travel speed is too fast to allow molten metal to flow into the weld crater created by the arc heat.

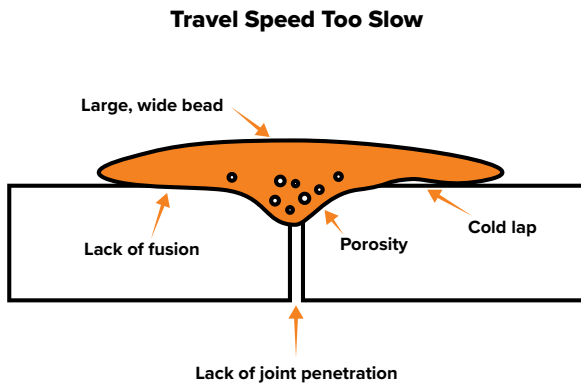

### 8.7.2 Travel Speed Too Slow

A too slow travel speed produces a large weld with a lack of penetration and fusion. The energy from the arc dwells on top of the weld pool rather than penetrating the base metal. This produces a wider weld bead with more deposited weld metal per mm than is required resulting in a weld deposit of poor quality.

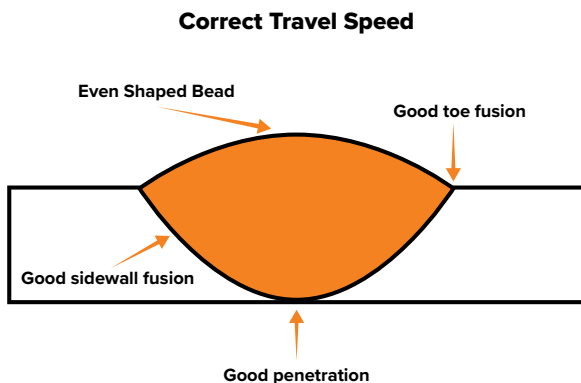

### 8.7.3 Correct Travel Speed

The correct travel speed keeps the arc at the leading edge of the weld pool allowing the base metal to melt sufficiently to create good penetration, fusion and wetting out of the weld pool producing a weld deposit of good quality.

## 8.8 Wire Types and Sizes

Use the correct wire type for the base metal being welded. Use stainless steel wire for stainless steel, aluminium wires for aluminium and steel wires for steel.

**Using poor quality milled wire can result in poor performance and appearance. To ensure optimal performance when welding, use standards approved wire such as UNIMIG HYPERMIG wire.**

Use a smaller diameter wire for thin base metals. For thicker materials use a larger wire diameter and larger machine. Check the recommended welding capability of your machine.

As a guide, refer to the "Welding Wire Thickness Chart" below.

Recommended Synergic Settings		Wire Size		
		0.6mm	0.8mm	0.9mm
Material Thickness	1mm	6	5-7	5-7
	2mm	8	7-9	7-9
	3mm	10	9-10	9-10
	4mm		10	10
	6mm		10	10

## 8.9 Gas Selection

The purpose of the gas in the MIG process is to shield the wire, the arc and the molten weld metal from the atmosphere. Most metals when heated to a molten state will react with the air in the atmosphere, without the protection of the shielding gas the weld produced would contain defects like porosity, lack of fusion and slag inclusions. Additionally, some of the gas becomes ionised (electrically charged) and helps the current flow smoothly.

The correct gas flow is critical in protecting the welding zone from the atmosphere.

Too low a flow will give inadequate coverage and result in weld defects and unstable arc conditions.

Too high a flow can cause air to be drawn into the gas column and contaminate the weld zone.

Use the correct shielding gas. CO<sub>2</sub> is suitable for steel and offers good penetration characteristics; the weld profile is narrower and slightly more raised than the weld profile obtained from Argon CO<sub>2</sub> mixed gas. Argon CO<sub>2</sub> mix gas offers better weldability for thin metals and has a wider range of setting tolerance on the machine. Argon 5/2 is a good all-round mix suitable for most applications.

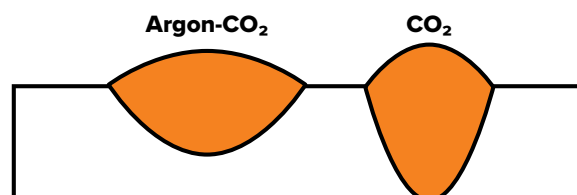

## 9. MMA: Machine Setup

1. For DC+ electrodes, connect earth clamp to the **negative (-)** dinse connection, and electrode holder to the **positive (+)** dinse connection.
2. For DC- electrodes, connect earth clamp to the **positive (+)** dinse connection, and electrode holder to the **negative (-)** dinse connection.

### DC+ Electrode

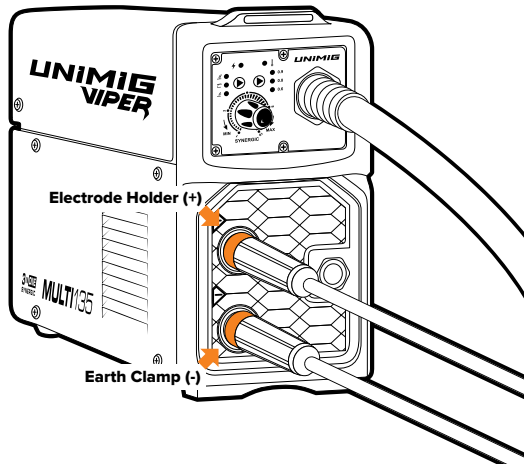

### DC- Electrode

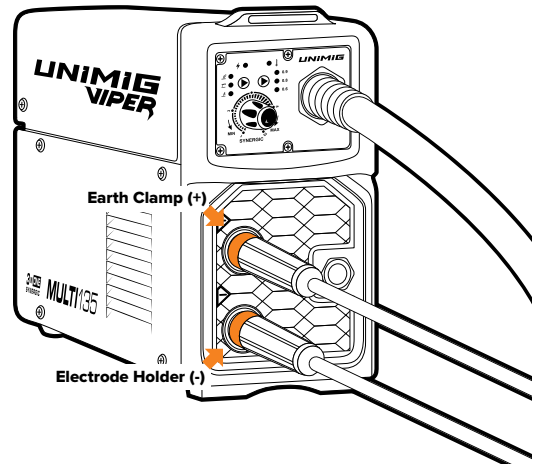

3. Connect the plug into a 10 AMP power point, then switch the machine ON.
4. Select MMA from the MIG/TIG/MMA selector.

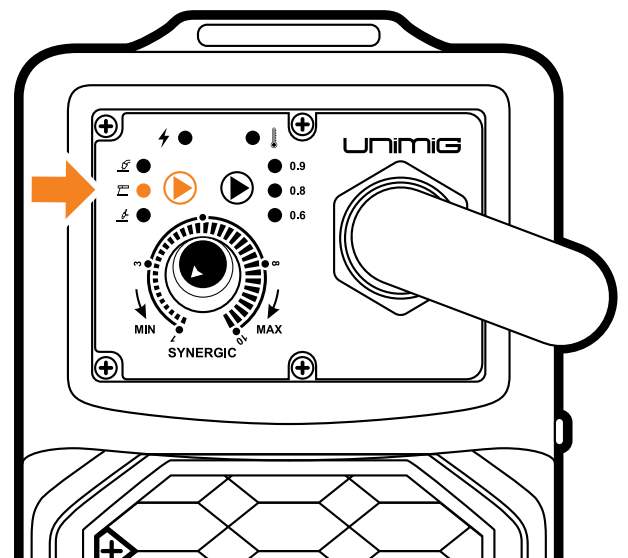
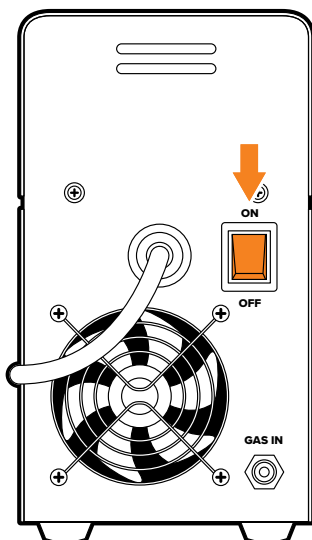

5. Push down handle to open up electrode holder grip.

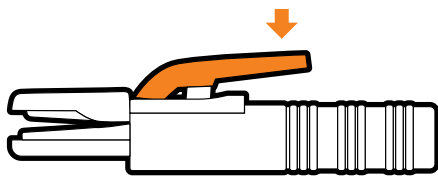

6. Place electrode into electrode holder.

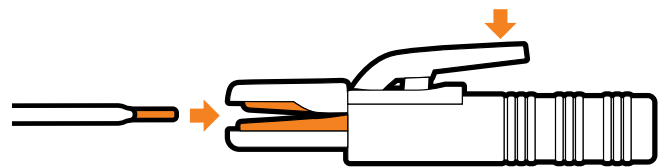

7. Release handle to securely grip electrode.

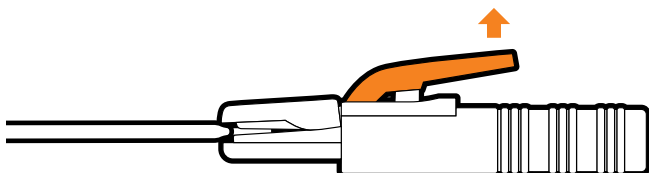

8. Adjust amperage to desired setting.

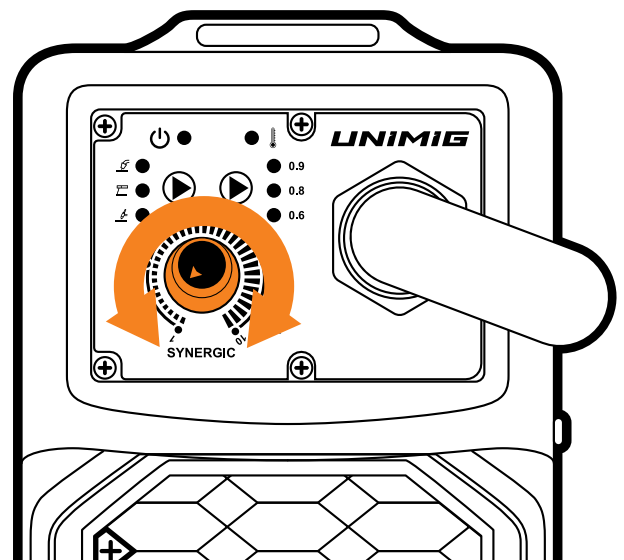

9. Connect earth clamp to your workpiece.

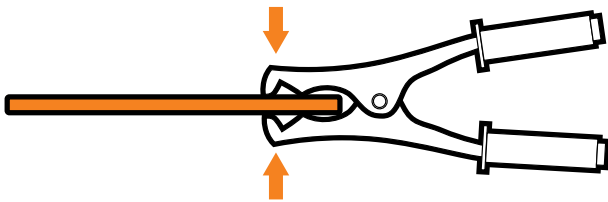

10. Strike electrode against workpiece to initiate arc.

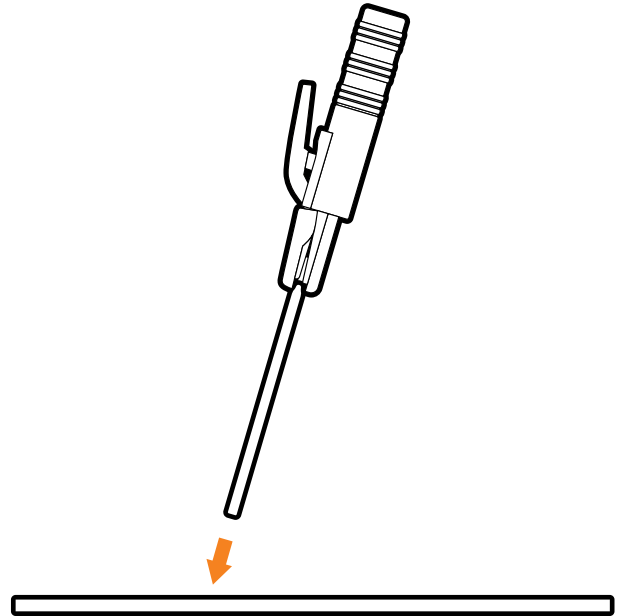

11. Drag along workpiece to weld. Pull the electrode away from the workpiece to finish weld.

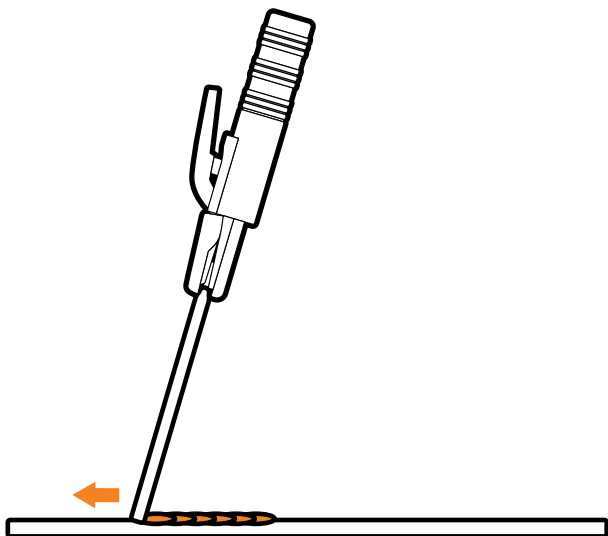

## 10. MMA: Welding Guide

One of the most common types of arc welding is Manual Metal Arc welding, also known as MMA welding. An electric current is used to strike an arc between the base material and a consumable electrode rod or 'stick'. The electrode rod is made of a material that is compatible with the base material being welded. They are covered with a flux that gives off gaseous vapours that serve as a shielding gas and provide a layer of slag, both of which protect the weld area from atmospheric contamination. The electrode core itself acts as filler material. The residue from the flux that forms a slag covering over the weld metal must be chipped away after welding.

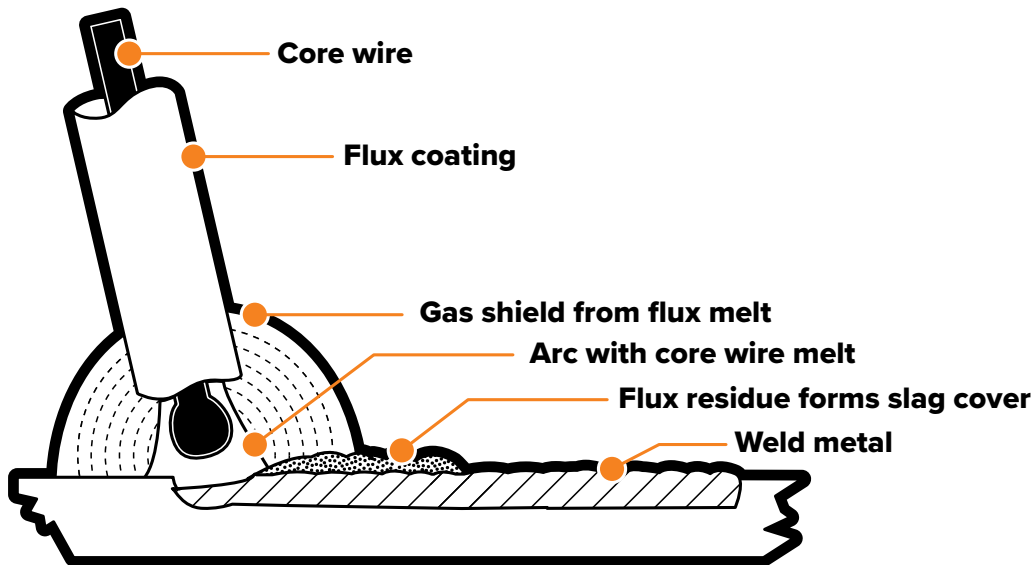

- The arc is initiated by momentarily touching the electrode to the base metal.
- The heat of the arc melts the surface of the base metal to form a molten pool at the end of the electrode.
- The melted electrode metal is transferred across the arc into the molten pool and becomes the deposited weld metal.
- The deposit is covered and protected by a slag which comes from the electrode coating.
- The arc and the immediate area are enveloped by an atmosphere of protective gas.

Manual Metal Arc (stick) electrodes have a solid metal wire core and a flux coating. These electrodes are identified by the wire diameter and by a series of letters and numbers. The letters and numbers identify the metal alloy and the intended use of the electrode.

The metal wire core works as a conductor of the current that maintains the arc. The core wire melts and is deposited into the welding pool.

The covering on a shielded metal arc welding electrode is called flux. The flux on the electrode performs many different functions.

These include:

- Producing a protective gas around the weld area.
- Providing fluxing elements and de-oxidisers.
- Creating a protective slag coating over the weld as it cools.
- Establishing arc characteristics.
- Adding alloying elements.

Covered electrodes serve many purposes in addition to adding filler metal to the molten pool. These additional functions are provided mainly by the covering on the electrode.

## 10.1 Electrode Selection

As a general rule, the selection of an electrode is straight forward, in that it is only a matter of selecting an electrode of similar composition to the parent metal. However, for some metals, there is a choice of several electrodes, each of which has particular properties to suit specific classes of work.

The size of the electrode generally depends on the thickness of the section being welded, and the thicker the section, the larger the electrode required. The table gives the maximum size of electrodes that may be used for various thicknesses of section based on using a general-purpose type 6013 electrode.

Correct current selection for a particular job is an important factor in arc welding. With the current set too low, it is difficult to strike and maintain a stable arc. The penetration is reduced and beads with a distinct rounded profile will be deposited. Too high a current is accompanied by overheating of the electrode, resulting in undercut, burning through of the base metal and producing excessive spatter.

Average Thickness of Material	Maximum Recommended Electrode Diameter
1.0 - 2.0mm	2.5mm
2.0 - 5.0mm	3.2mm
5.0 - 8.0mm	4.0mm
8.0 - > mm	5.0mm

Electrode Size (ø mm)	Current Range (Amps)
2.5mm	60 - 100
3.2mm	100 - 130
4.0mm	130 - 165
5.0mm	165 - 260

## 10.2 Arc Length

To strike the arc, the electrode should be gently scraped on the work until the arc is established. There is a simple rule for the proper arc length; it should be the shortest arc that gives a good surface to the weld. An arc too long reduces penetration, produces spatter and gives a rough surface finish to the weld. An excessively short arc will cause sticking of the electrode and result in poor quality welds. The general rule of thumb for down hand welding is to have an arc length no greater than the diameter of the core wire.

## 10.3 Electrode Angle

The angle that the electrode makes with the work is important to ensure a smooth, even transfer of metal. When welding in down hand, fillet, horizontal or overhead, the angle of the electrode is generally between 5 and 15 degrees towards the direction of travel. When vertical up welding, the angle of the electrode should be between 80 and 90 degrees to the workpiece.

## 10.4 Travel Speed

The electrode should be moved along in the direction of the joint being welded at a speed that will give the size of run required. At the same time, the electrode is fed downwards to keep the correct arc length at all times. Excessive travel speeds lead to poor fusion, lack of penetration, etc., while too slow a rate of travel will frequently lead to arc instability, slag inclusions and poor mechanical properties.

## 10.5 Material and Joint Preparation

The material to be welded should be clean and free of any moisture, paint, oil, grease, mill scale, rust or any other material that will hinder the arc and contaminate the weld material. Joint preparation will depend on the method used include sawing, punching, shearing, machining, flame cutting and others. In all cases, edges should be clean and free of any contaminates. The chosen application will determine the type of joint.



## 11. TIG: Machine Setup

1. Connect the TIG torch to the **negative (-)** dinse connection, twist to lock in place.
2. Connect the earth clamp to the **positive (+)** dinse connection, twist to lock in place.

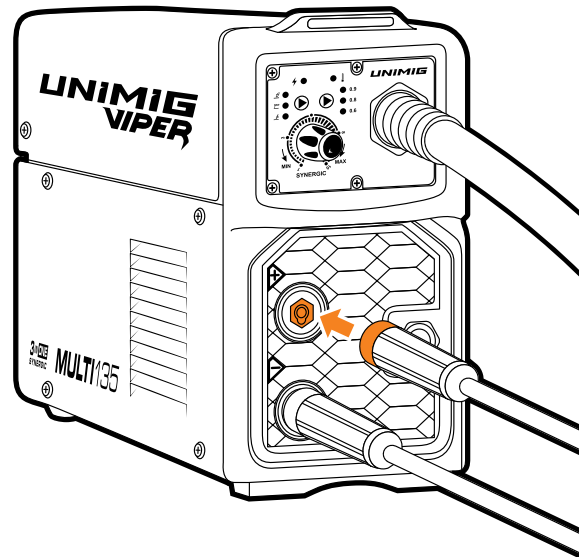
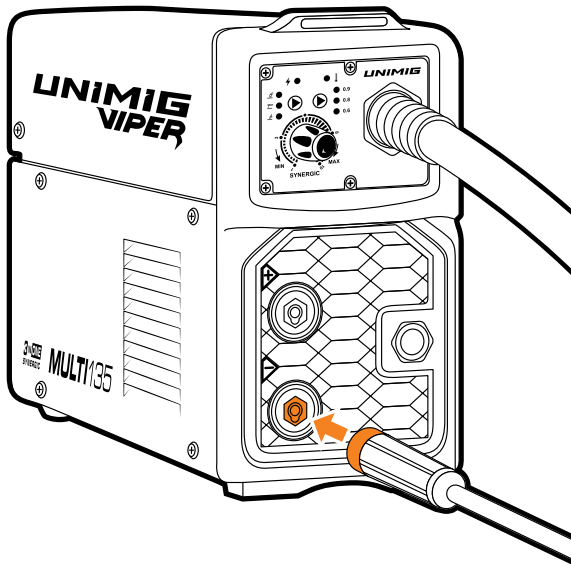

3. Connect the plug into a 10 AMP power point, then switch the machine ON.
4. Select TIG from the MIG/TIG/MMA selector.

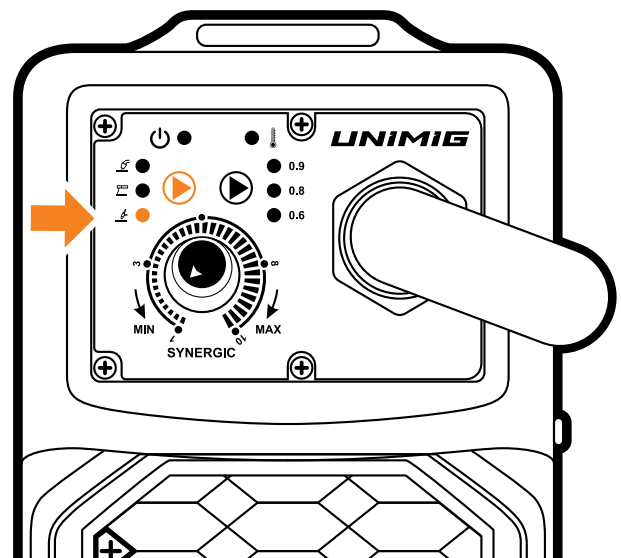
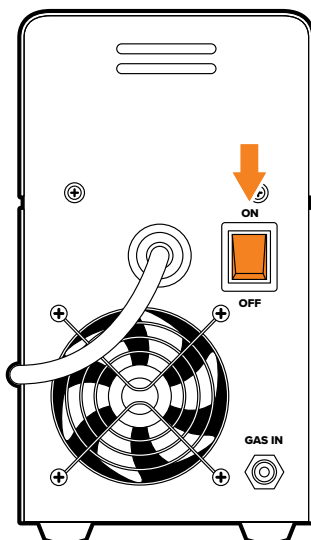

5. Place argon flowmeter regulator into your gas outlet.

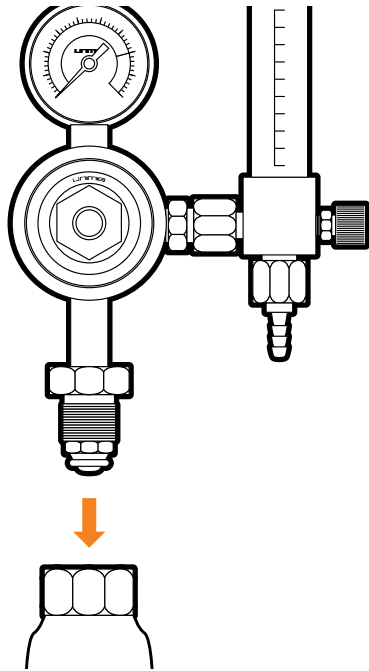

6. Tighten securely with wrench.

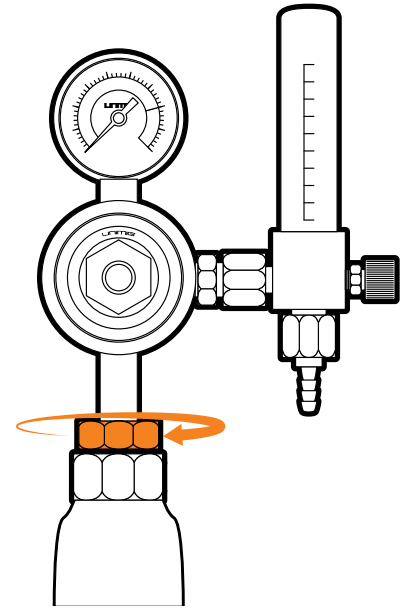

7. Connect gas hose to the flowmeter outlet, and crimp in place.

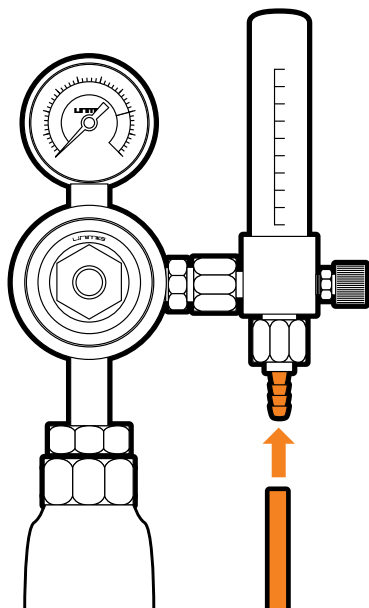

8. Adjust gas flow to 6-12L/min.

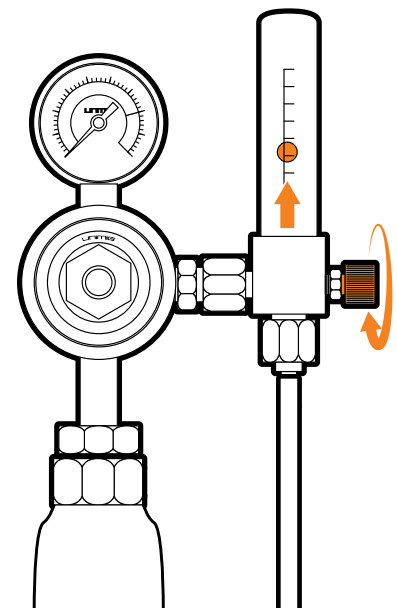

9. Set the welding current using the amperage control dial.

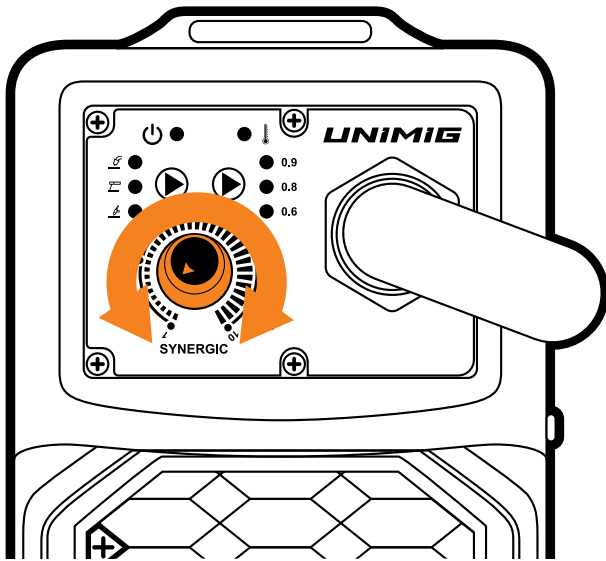

10. Connect earth clamp to your workpiece.

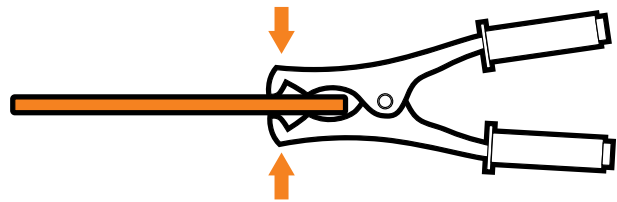

11. Turn on the gas valve located on the TIG torch handle.

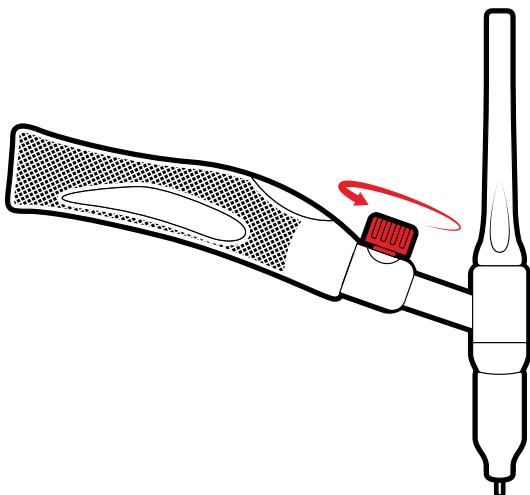

12. Lay the outside edge of the gas cup on the workpiece with the tungsten electrode 1-2mm from the workpiece.

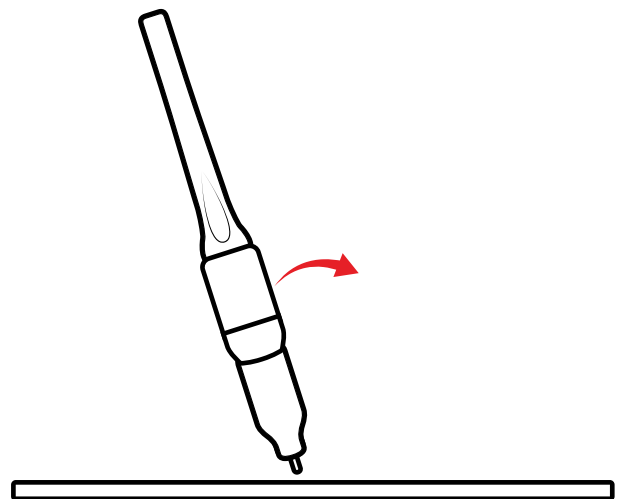

**13.** With a small movement rotate the gas cup forward so that the tungsten electrode touches the workpiece.

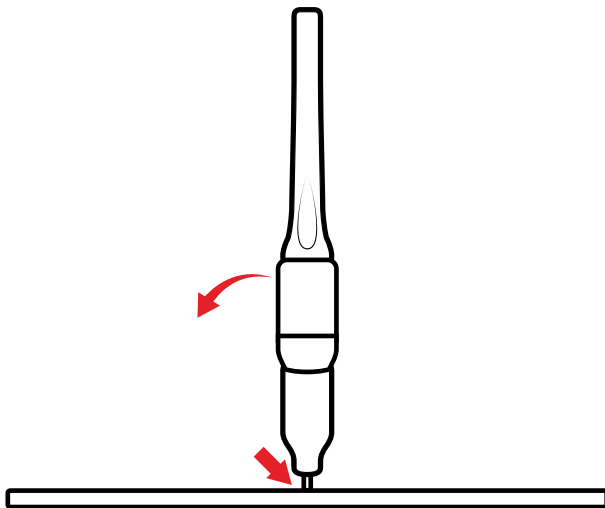

**14.** Now rotate the gas cup in the reverse direction to lift the tungsten electrode from the workpiece to create the arc.

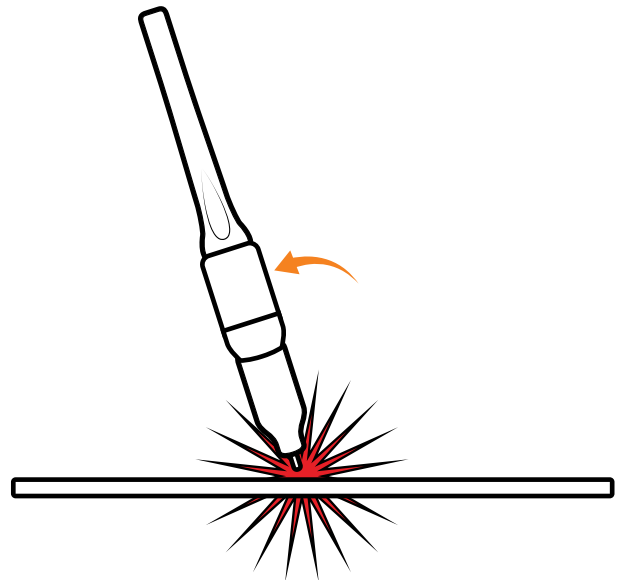

**IMPORTANT! - We strongly recommend that you check for gas leakage prior to operation of your machine. We recommend that you close the cylinder valve when the machine is not in use.**

**Welding Guns Of Australia PTY LTD, authorised representatives or agents of Welding Guns Of Australia PTY LTD will not be liable or responsible for the loss of any gas.**

## 12. TIG: Welding Guide

### 12.1 DC TIG Welding

The DC power source uses what is known as DC (direct current) in which the main electrical component known as electrons flow in only one direction from the negative pole (terminal) to the positive pole (terminal). In the DC electrical circuit, there is an electrical principle at work which should always be taken into account when using any DC circuit. With a DC circuit, 70% of the energy (heat) is always on the positive side. This needs to be understood because it determines what terminal the TIG torch will be connected to (this rule applies to all the other forms of DC welding as well).

DC TIG welding is a process in which an arc is struck between a tungsten electrode and the metal workpiece. The weld area is shielded by an inert gas flow to prevent contamination of the tungsten, molten pool and weld area. When the TIG arc is struck, the inert gas is ionised and superheated, changing its molecular structure, which converts it into a plasma stream. This plasma stream flowing between the tungsten and the workpiece is the TIG arc and can be as hot as 19,000°C. It is a very pure and concentrated arc which provides the controlled melting of most metals into a weld pool. TIG welding offers the user the highest amount of flexibility to weld the widest range of material thickness and types. DC TIG welding is also the cleanest weld with no sparks or spatter.

The intensity of the arc is proportional to the current that flows from the tungsten. The welder regulates the welding current to adjust the power of the arc. Typically thin material requires a less powerful arc with less heat to melt the material, so less current (amps) is required. Thicker material requires a more powerful arc with more heat, so more current (amps) are necessary to melt the material.

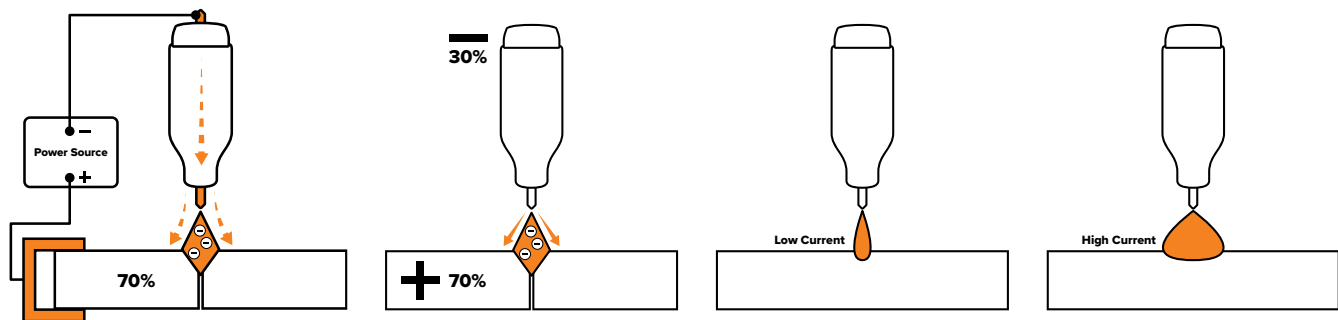

### 12.2 Lift Arc Ignition for TIG (Tungsten Inert Gas) Welding

Lift Arc is a form of arc ignition where the tungsten electrode is touched to the workpiece and then pulled upwards to initiate an arc. When the machine detects that the tungsten has left the surface and a spark is present, it immediately (within microseconds) increases power, converting the spark to a full arc. It is a simple, safe, lower-cost alternative arc ignition process to HF (high frequency) and a superior arc start process to scratch start.

Lift Arc ignition allows the arc to be started easily in DC TIG by simply touching the tungsten to the workpiece and lifting it to start the arc. This prevents the tungsten tip from sticking to the workpiece and breaking the tip from the tungsten electrode. There is a particular technique called “rocking the cup” used in the Lift Arc process that provides easy use of the Lift Arc function.

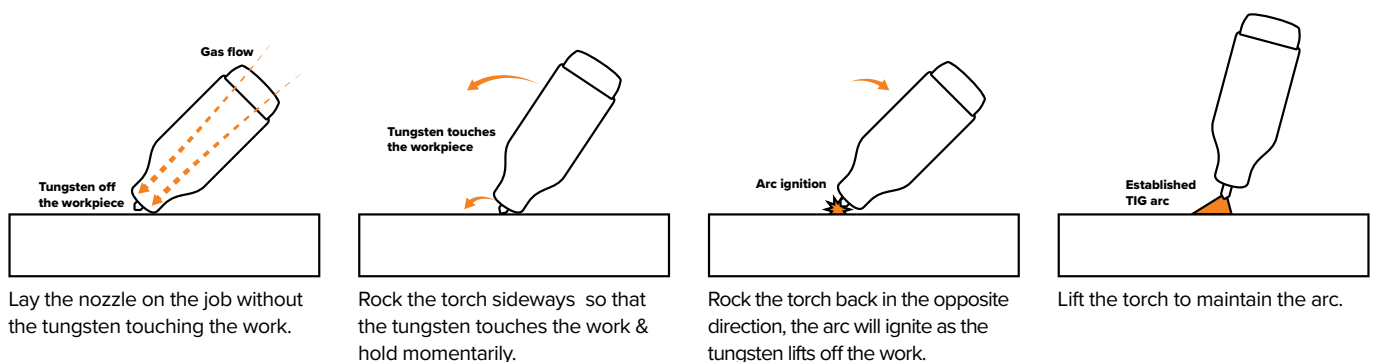

## 12.3 TIG Welding Fusion Technique

Manual TIG welding is often considered the most difficult of all the welding processes. Because the welder must maintain a short arc length, great care and skill are required to prevent contact between the electrode and the workpiece. Similar to Oxygen Acetylene torch welding, TIG welding typically requires two hands and in most instances requires the welder to manually feed a filler wire into the weld pool with one hand while manipulating the welding torch in the other. However, some welds combining thin materials can be accomplished without filler metal, such as edge, corner, and butt joints. This is known as Fusion welding where the edges of the metal pieces are melted together using only the heat and arc force generated by the TIG arc. Once the arc is started, the torch tungsten is held in place until a weld pool is created, a circular movement of the tungsten will assist in creating a weld pool of the desired size. Once the weld pool is established, tilt the torch at about a 75° angle and move smoothly and evenly along the joint while fusing the materials together.

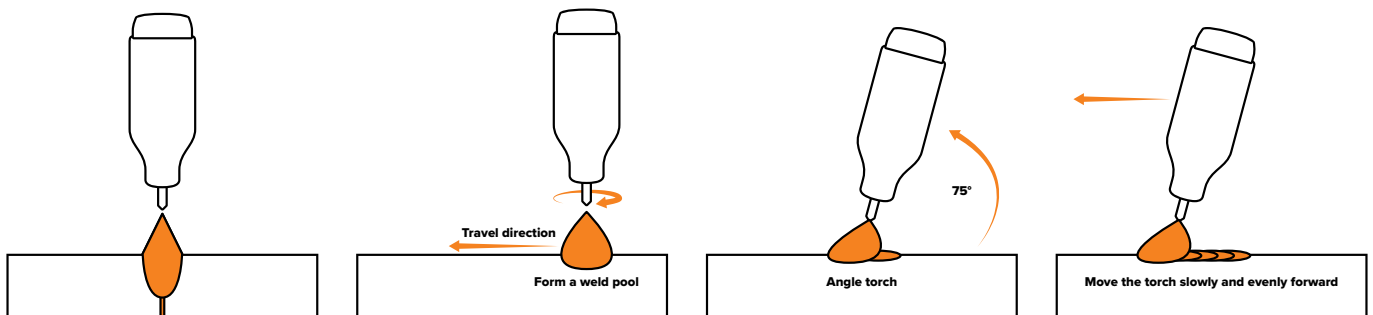

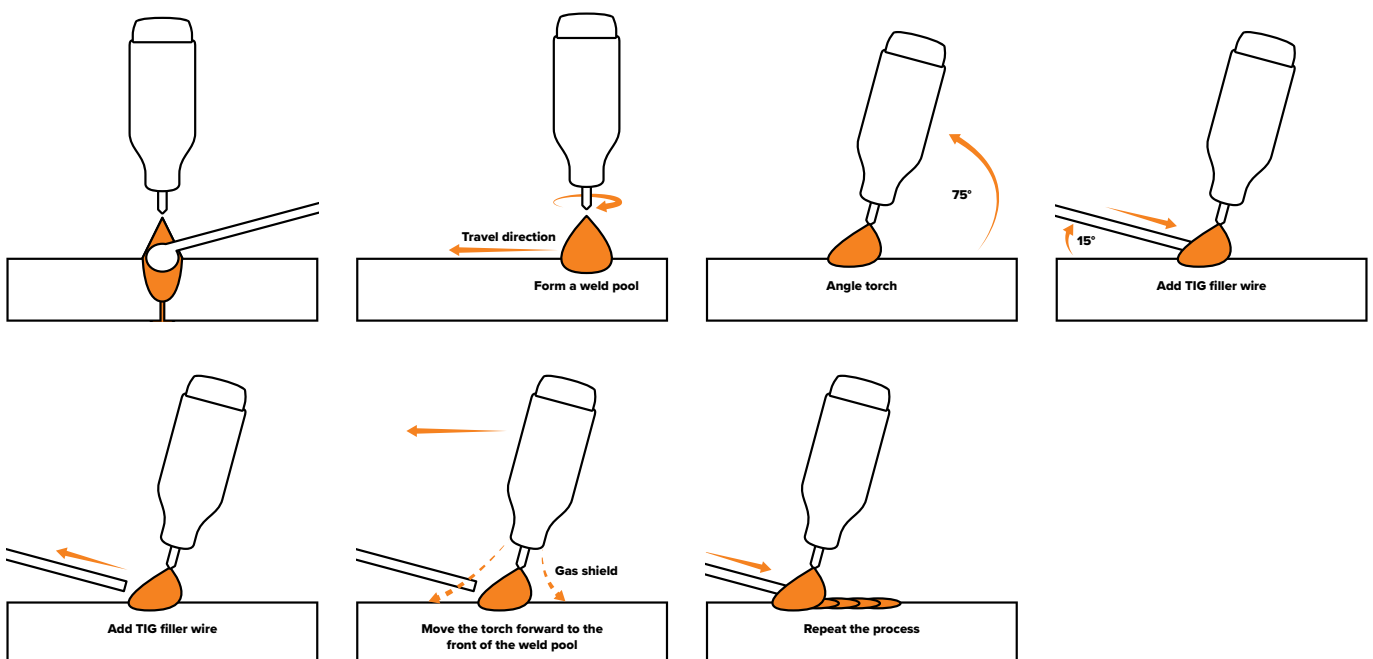

## 12.4 TIG Welding with Filler Wire Technique

It is necessary for many situations with TIG welding to add a filler wire into the weld pool to build up weld reinforcement and create a strong weld. Once the arc is started, the torch tungsten is held in place until a weld pool is created, a circular movement of the tungsten will assist in creating a weld pool of the desired size. Once the weld pool is established, tilt the torch at about a 75° angle and move smoothly and evenly along the joint. The filler metal is introduced to the leading edge of the weld pool. The filler wire is usually held at about a 15° angle and fed into the leading edge of the molten pool. The arc will melt the filler wire into the weld pool as the torch is moved forward. Also, a dabbing technique can be used to control the amount of filler wire added. The wire is fed into the molten pool and retracted in a repeating sequence as the torch is moved slowly and evenly forward. It is essential during the welding to keep the molten end of the filler wire inside the gas shield as this protects the end of the wire from being oxidised and contaminating the weld pool.



## 12.5 TIG Tungsten Selection Guide

	 LANTHANATED (GOLD)	 ZIRCONIATED (WHITE)	 THORIATED (RED)	 RARE EARTH (PURPLE)	 CERIATED (GREY)
AC CURRENT	✓	✓		✓	✓
DC CURRENT	✓		✓	✓	✓
ALUMINIUM	✓	✓		✓	✓
MILD STEEL	✓		✓	✓	✓
STAINLESS STEEL	✓		✓	✓	✓
TITANIUM / COPPER ALLOYS	✓		✓	✓	✓
ARC IGNITION	●●●●●	●●●●●	●●●●●	●●●●●	●●●●●
TUNGSTEN LIFE	●●●●●	●●●●●	●●●●●	●●●●●	●●●●●
ARC STABILITY	●●●●●	●●●●●	●●●●●	●●●●●	●●●●●
RESISTANCE TO CONTAMINATION	●●●●●	●●●●●	●●●●●	●●●●●	●●●●●
AC PERFORMANCE	●●●●●	●●●●●	N/A	●●●●●	●●●●●

This information is intended to act as a guide only, individual results may vary depending on technique, skill and material.

## 12.6 Tungsten Electrodes Rating for Welding Currents

Tungsten Diameter (mm)	Diameter at the Tip (mm)	Constant Included Angle (°)	Current Range (Amps)	Current Range (Pulsed Amps)
1.0mm	0.25	20	5 - 30	5 - 60
1.6mm	0.5	25	8 - 50	5 - 100
1.6mm	0.8	30	10 - 70	10 - 140
2.4mm	0.8	35	12 - 90	12 - 180
2.4mm	1.1	45	15 - 150	15 - 250
3.2mm	1.1	60	20 - 200	20 - 300
3.2mm	1.5	90	25 - 250	25 - 350

## 12.7 Tungsten Preparation

Always use DIAMOND wheels when grinding and cutting. While tungsten is a tough material, the surface of a diamond wheel is harder, and this makes for smooth grinding. Grinding without diamond wheels, such as aluminium oxide wheels, can lead to jagged edges, imperfections, or poor surface finishes not visible to the eye that will contribute to weld inconsistency and weld defects.

Always ensure to grind the tungsten in a longitudinal direction on the grinding wheel. Tungsten electrodes are manufactured with the molecular structure of the grain running lengthwise and thus grinding crosswise is "grinding against the grain." If electrodes are ground crosswise, the electrons have to jump across the grinding marks, and the arc can start before the tip and wander. Grinding longitudinally with the grain causes the electrons to flow steadily and easily to the end of the tungsten tip. The arc starts straight and remains narrow, concentrated, and stable.

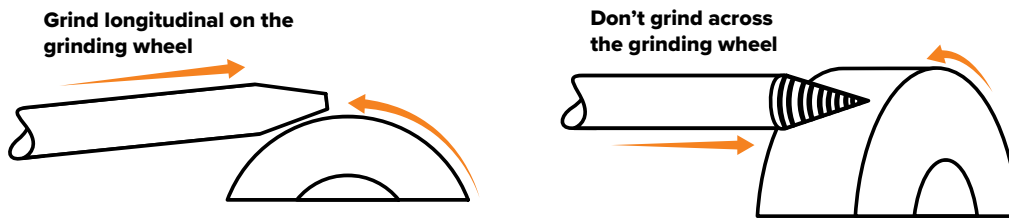

## 12.8 Electrode Tip/Flat

The shape of the tungsten electrode tip is an important process variable in precision arc welding. A good selection of tip/flat size will balance the need for several advantages. The bigger the flat, the more likely arc wander will occur and the more difficult it will be to arc start. However, increasing the flat to the maximum level that still allows arc starts and eliminates arc wander will improve the weld penetration and increase the electrode life. Some welders still grind electrodes to a sharp point, which makes arc starting easier. However, they risk decreased welding performance from melting at the tip and the possibility of the point falling off into the weld pool.



## 12.9 Electrode Included Angle/Taper - DC

Tungsten electrodes for DC welding should be ground longitudinally and concentrically with diamond wheels to a specific included angle in conjunction with the tip/flat preparation. Different angles produce different arc shapes and offer different weld penetration capabilities. In general, blunter electrodes that have a larger included angle provide the following benefits:

- Last longer
- Have better weld penetration
- Have a narrower arc shape
- Can handle more amperage without eroding

Sharper electrodes with smaller included angle provide:

- Offer less arc weld
- Have a wider arc
- Have a more consistent arc

The included angle determines the weld bead shape and size. Generally, as the included angle increases, penetration increases and bead width decreases.





## 13. Drive Roller Selection

The importance of smooth, consistent wire feeding during MIG welding cannot be emphasised enough. The smoother the wire feed, the better the welding will be. Feed rollers or drive rollers are used to feed the wire mechanically along the length of the welding gun.

Feed rollers are designed to be used for certain types of welding wire, and they have different types of grooves machined in them to accommodate the different types of wire. The wire is held in the groove by the top roller of the wire drive unit and is referred to as the pressure roller. Pressure is applied by a tension arm that can be adjusted to increase or decrease the pressure as required. The type of wire will determine how much pressure can be applied and what type of drive roller is best suited to obtain optimum wire feed.

### 13.1 Solid Hard Wire (V Groove)

Steel or stainless steel require a drive roller with a V shape groove for optimum grip and drive capability. Solid wires can have more tension applied to the wire from the top pressure roller that holds the wire in the groove, and the V shape groove is more suited for this. Solid wires are more forgiving to feed due to their higher cross-sectional column strength. They are stiffer and don't bend so easily.

### 13.2 Flux Cored / Gasless Wire (Knurled/F Groove)

These wires are made up of a thin metal sheath that has fluxing, and metal compounds layered onto it and then rolled into a cylinder to form the finished wire. The wire cannot take too much pressure from the top roller as it can be crushed and deformed if too much pressure is applied. A Knurled/F groove drive roller has been developed, and it has small serrations in the groove. The serrations grip the wire and assist in driving it without too much pressure from the top roller. The downside to the knurled wire feed roller on flux-cored wire is it will slowly eat away at the surface of the welding wire, and these small pieces will eventually go down into the liner. This will cause clogging in the liner and added friction that will lead to welding wire feed problems. A U groove wire can also be used for flux cored wire without the wire particles coming off the wire surface. However, it is considered that the Knurled roller will give a more positive feed of flux cored wire without any deformation of the wire shape.

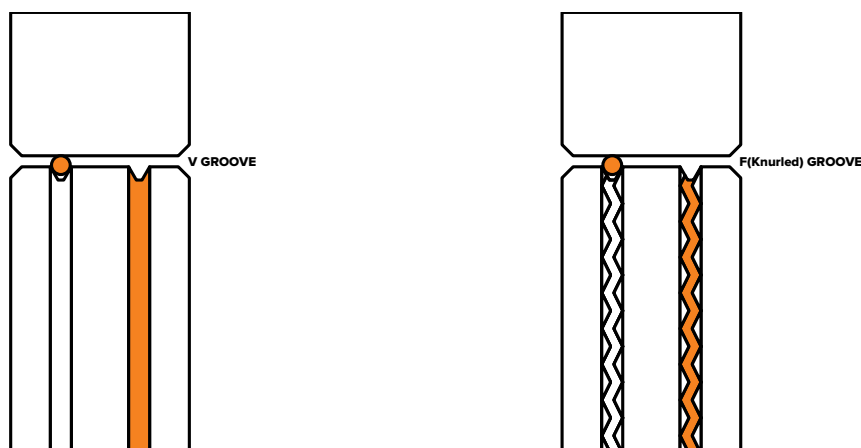

## 13.3 VIPER 135 SYNERGIC Rollers

### 13.3.1 V Groove Roller (Steel Wire)

SKU	Description
U51002	VIPER 135 ROLLER - 25/9 - 0.6/0.8 V GROOVE
U51003	VIPER 135 ROLLER - 25/9 - 0.8/0.9 V GROOVE

### 13.3.2 Knurled/F Groove (Flux-Cored Wire)

SKU	Description
U51004	VIPER 135 ROLLER - 25/9 - 0.8/0.9 F GROOVE

## 14. MIG Torch Consumables



SKU	Description	QTY
PCTH14	TIP HOLDER	2



SKU	Description	QTY
PGNS15	NOZZLE SPRING	2



SKU	Description	QTY
PCT0008-06	CONTACT TIPS - Steel 0.6mm	10
PCT0008-08	CONTACT TIPS - Steel 0.8mm	10
PCT0008-09	CONTACT TIPS - Steel 0.9mm	10



SKU	Description	QTY
PGN15CON	GAS NOZZLE - Conical	2
PGN15CYL	GAS NOZZLE - Cylindrical	2
PGN15SPOT	GAS NOZZLE - Spot	2
PGN15TAP	GAS NOZZLE - Tapered	2
PGN15GLN	GASLESS NOZZLE	2

## 15. MIG Troubleshooting

### 15.1 Excessive Spatter

- **Wire feed speed set too high:** Select lower wire feed speed.
- **Voltage too high:** Select a lower voltage setting.
- **Wrong polarity set:** Select the correct polarity for the wire being used - see machine setup guide.
- **Stick out too long:** Bring the torch closer to the work.
- **Contaminated base metal:** Remove materials like paint, grease, oil, and dirt, including mill scale from base metal.
- **Contaminated MIG wire:** Use clean, dry, rust-free wire. Do not lubricate the wire with oil, grease etc.
- **Inadequate gas flow or too much gas flow:** Check the gas is connected, check hoses, gas valve and torch are not restricted. Set the gas flow between 8-12L/min flow rate. Check hoses and fittings for holes, leaks etc.

### 15.2 Porosity - Small cavities or holes resulting from gas pockets in weld metal

- **Wrong gas:** Check that the correct gas is being used.
- **Inadequate gas flow or too much gas flow:** Check the gas is connected, check hoses, gas valve and torch are not restricted. Set the gas flow between 8-12L/min flow rate. Check hoses and fittings for holes, leaks etc. Protect the welding zone from wind and drafts.
- **Moisture on the base metal:** Remove all moisture from base metal before welding.
- **Contaminated base metal:** Remove materials like paint, grease, oil, and dirt, including mill scale from base metal.
- **Contaminated MIG wire:** Use clean, dry, rust-free wire. Do not lubricate the wire with oil, grease etc.
- **Gas nozzle clogged with spatter, worn or out of shape:** Clean or replace the gas nozzle.
- **Missing or damaged gas diffuser:** Replace the gas diffuser.
- **MIG torch Euro connect O-ring missing or damaged:** Check and replace the O-ring.

### 15.3 Wire stubbing during welding

- **Holding the torch too far away:** Bring the torch closer to the work and maintain stick out of 5-10mm.
- **Welding voltage set too low:** Increase the voltage.
- **Wire feed speed set too high:** Decrease the wire feed speed.

### 15.4 Lack of fusion - Failure of weld metal to fuse completely with base metal or a preceding weld bead

- **Contaminated base metal:** Remove materials like paint, grease, oil, and dirt, including mill scale from base metal.
- **Not enough heat input:** Select a higher voltage range and/or adjust the wire speed to suit.
- **Improper welding technique:** Keep the arc at the leading edge of the weld pool. Gun angle to work should be between 5° & 15°. Direct the arc at the weld joint. Adjust work angle or widen groove to access bottom during welding. Momentarily hold arc on side walls if using weaving technique.

### 15.5 Excessive penetration - Weld metal melting through base metal

- **Too much heat:** Select a lower voltage range and/or adjust the wire speed to suit. Increase travel speed.

## 15.6 Lack of penetration - Shallow fusion between weld metal and base metal

- **Poor or incorrect joint preparation:** Material too thick. Joint preparation and design needs to allow access to bottom of groove while maintaining proper welding wire extension and arc characteristics. Keep the arc at the leading edge of the weld pool and maintain the gun angle at 5° & 15° keeping the stick out between 5-10mm.
- **Not enough heat input:** Select a higher voltage range and/or adjust the wire speed to suit. Reduce travel speed.
- **Contaminated base metal:** Remove materials like paint, grease, oil, and dirt, including mill scale, from base metal.

## 15.7 No wire feed

- **Wrong mode selected:** Check that the TIG/MMA/MIG selector switch is set to MIG position.
- **Wrong torch selector switch:** Check that the STANDARD/SPOOL GUN selector switch is set to STANDARD position for MIG welding and SPOOL GUN when using the spool gun.

## 15.8 Inconsistent/interrupted wire feed

- **Adjusting wrong dial:** Be sure to adjust the WIRE FEED and VOLTAGE dials for MIG welding. The AMPERAGE dial is for STICK and TIG welding mode.
- **Wrong polarity selected:** Select the correct polarity for the wire being used - see machine setup guide.
- **Incorrect wire speed setting:** Adjust the wire feed speed.
- **Voltage setting incorrect:** Adjust the voltage setting.
- **MIG torch lead too long:** Small diameter wires and soft wires like aluminium don't feed well through long torch leads - replace the torch with a lesser length torch.
- **MIG torch lead kinked or too sharp angle being held:** Remove the kink, reduce the angle or bend.
- **Contact tip worn, wrong size, wrong type:** Replace the tip with correct size and type.
- **Liner worn or clogged (the most common causes of bad feeding):** Try to clear the liner by blowing out with compressed air as a temporary cure. It is recommended to replace the liner.
- **Wrong size liner:** Install the correct size liner.
- **Blocked or worn inlet guide tube:** Clear or replace the inlet guide tube.
- **Wire misaligned in drive roller groove:** Locate the wire into the groove of the drive roller.
- **Incorrect drive roller size:** Fit the correct size drive roller e.g. 0.8mm wire requires 0.8mm drive roller.
- **Wrong type of drive roller selected:** Fit the correct type roller (e.g. knurled rollers needed for flux cored wires).
- **Worn drive rollers:** Replace the drive rollers.
- **Drive roller pressure too high:** Can flatten the wire electrode causing it to lodge in the contact tip - reduce the drive roller pressure.
- **Too much tension on wire spool hub:** Reduce the spool hub brake tension.
- **Wire crossed over on the spool or tangled:** Remove the spool, untangle the wire or replace the wire.
- **Contaminated MIG wire:** Use clean, dry, rust-free wire. Do not lubricate the wire with oil, grease etc.

## 16. TIG Troubleshooting

### 16.1 Tungsten burning away quickly

- **Incorrect gas or no gas:** Use pure argon. Check cylinder has gas is connected, turned on and torch valve is open.
- **Inadequate gas flow:** Check the gas is connected, check hoses, gas valve and torch are not restricted.
- **Back cap not fitted correctly:** Make sure the torch back cap is fitted so that the O-ring is inside the torch body.
- **Torch connected to DC+:** Connect the torch to the DC- output terminal.
- **Incorrect tungsten being used:** Check and change the tungsten type if necessary.
- **Tungsten being oxidised after weld is finished:** Keep shielding gas flowing 10-15 seconds after arc stoppage. 1 second for each 10 amps of weld current.

### 16.2 Contaminated tungsten

- **Touching tungsten into the weld pool:** Keep tungsten from contacting weld puddle. Raise the torch so that the tungsten is off of the work piece 2-5mm.
- **Touching the filler wire to the tungsten:** Keep the filler wire from touching the tungsten during welding, feed the filler wire into the leading edge of the weld pool in front of the tungsten.

### 16.3 Porosity - Poor weld appearance and colour

- **Wrong gas / poor gas flow / gas leaks:** Use pure argon. Gas is connected, check hoses, gas valve and torch are not restricted. Set the gas flow between 6-12 L/min. Check hoses and fittings for holes, leaks etc.
- **Contaminated base metal:** Remove moisture and materials like paint, grease, oil, and dirt from base metal.
- **Contaminated filler wire:** Remove all grease, oil, or moisture from filler metal.
- **Incorrect filler wire:** Check the filler wire and change if necessary.

### 16.4 Yellowish residue/smoke on the alumina nozzle & discoloured tungsten

- **Incorrect gas:** Use pure argon gas.
- **Inadequate gas flow:** Set the gas flow between 6-12 L/min flow rate.
- **Alumina gas nozzle too small:** Increase the size of the alumina gas nozzle.

### 16.5 Unstable arc during DC welding

- **Torch connected to DC+:** Connect the torch to the DC- output terminal.
- **Contaminated base metal:** Remove materials like paint, grease, oil, and dirt, including mill scale from base metal.
- **Tungsten is contaminated:** Remove 10mm of contaminated tungsten and re-grind the tungsten.
- **Arc length too long:** Lower torch so that the tungsten is off of the work piece 2-5mm.

## 16.6 Arc wanders during DC welding

- **Poor gas flow:** Check and set the gas flow between 6-12 L/min flow rate.
- **Amperage too low:** Increase the amperage.
- **Incorrect arc length:** Lower torch so that the tungsten is off of the work piece 2-5mm.
- **Tungsten incorrect or in poor condition:** Check that correct type of tungsten is being used. Remove 10mm from the weld end of the tungsten and re-sharpen the tungsten.
- **Poorly prepared tungsten:** Grind marks should run lengthwise with tungsten, not circular. Use proper grinding method and wheel.
- **Contaminated base metal or filler wire:** Remove contaminating materials like paint, grease, oil, and dirt, including mill scale, from base metal. Remove all grease, oil, or moisture from filler metal.

## 16.7 Arc difficult to start or will not start DC welding

- **Incorrect machine set up:** Check machine set up is correct.
- **No gas, incorrect gas flow:** Check the gas is connected and cylinder valve open, check hoses, gas valve and torch are not restricted. Set the gas flow between 6-12 L/min flow rate.
- **Incorrect tungsten size or type:** Check and change the size and or the tungsten if required.
- **Loose connection:** Check all connectors and tighten.
- **Earth clamp not connected to work:** Connect the earth clamp directly to the workpiece wherever possible.

## 17. MMA (STICK) Troubleshooting

### 17.1 No arc

- **Incomplete welding circuit:** Check earth lead is connected. Check all cable connections.
- **Wrong mode selected:** Check the MMA selector switch is selected.
- **No power supply:** Check that the machine is switched on and has a power supply.

### 17.2 Porosity - Small cavities or holes resulting from gas pockets in weld metal

- **Arc length too long:** Shorten the arc length.
- **Work piece dirty, contaminated or moisture:** Remove moisture and materials like paint, grease, oil, and dirt, including mill scale, from base metal.
- **Damp electrodes:** Use only dry electrodes.

### 17.3 Excessive Spatter

- **Amperage too high:** Decrease the amperage or choose a larger electrode.
- **Arc length too long:** Shorten the arc length.

### 17.4 Weld sits on top, lack of fusion

- **Insufficient heat input:** Increase the amperage or choose a larger electrode.
- **Work piece dirty, contaminated or moisture:** Remove moisture and materials like paint, grease, oil, and dirt, including mill scale, from base metal.
- **Poor welding technique:** Use the correct welding technique or seek assistance for the correct technique.

### 17.5 Lack of penetration

- **Insufficient heat input:** Increase the amperage or choose a larger electrode.
- **Poor welding technique:** Use the correct welding technique or seek assistance for the correct technique.
- **Poor joint preparation:** Check the joint design and fit up, make sure the material is not too thick. Seek assistance for the correct joint design and fit up.

### 17.6 Excessive penetration - Burn through

- **Excessive heat input:** Reduce the amperage or use a smaller electrode.
- **Incorrect travel speed:** Try increasing the weld travel speed.

### 17.7 Uneven weld appearance

- **Unsteady hand, wavering hand:** Use two hands where possible to steady up, practise your technique.

### 17.8 Distortion - Movement of base metal during welding

- **Excessive heat input:** Reduce the amperage or use a smaller electrode.
- **Poor welding technique:** Use the correct welding technique or seek assistance for the correct technique.
- **Poor joint preparation and or joint design:** Check the joint design and fit up, make sure the material is not too thick. Seek assistance for the correct joint design and fit up.

### 17.9 Electrode welds with different or unusual arc characteristic

- **Incorrect polarity:** Change the polarity, check the electrode manufacturer for correct polarity.

# UNIMIG

B U I L T F O R W E L D E R S

[unimig.com.au](http://unimig.com.au)

    @UNIMIG

**HEAD OFFICE:**

112 Christina Rd,  
Villawood NSW 2163

PH: (02) 9780 4200  
FAX: (02) 9780 4210

EMAIL: [sales@unimig.com.au](mailto:sales@unimig.com.au)

**QLD OFFICE:**

19 Commerce Cct,  
Yatala QLD 4207

PH: (07) 3333 2855  
FAX: (07) 3274 5829

EMAIL: [qld@unimig.com.au](mailto:qld@unimig.com.au)

**VIC OFFICE:**

91 Yellowbox Drive,  
Craigieburn VIC 3064

PH: (03) 8682 9911  
FAX: (03) 9333 7867

EMAIL: [sales@unimig.com.au](mailto:sales@unimig.com.au)

**WA OFFICE:**

26 Sustainable Ave,  
Bibra Lake WA 6163

PH: (08) 6363 5111  
FAX: (08) 9417 4781

EMAIL: [wasales@unimig.com.au](mailto:wasales@unimig.com.au)