

UNIMIG



RAZOR

MULTI230 AC/DC



CONTENTS

GENERAL INFORMATION

SAFETY.....	4
TECHNICAL DATA.....	8
MACHINE LAYOUT.....	9
WHAT'S IN THE BOX.....	11

DIGITAL SCREEN OPERATION

DIGITAL SCREEN - BASIC OPERATION.....	12
DIGITAL SCREEN - SETTINGS MENU.....	13
DIGITAL SCREEN - MMA (STICK).....	14
DIGITAL SCREEN - MIG.....	15
DIGITAL SCREEN - MIG SMART-SET.....	16
DIGITAL SCREEN - TIG.....	18

MIG SETUP

SETUP FOR MIG (GASLESS).....	21
SETUP FOR MIG (GAS-SHIELDED).....	27
MIG WELDING GUIDE.....	34
SETUP FOR SPOOL GUN.....	39
CHANGING THE MIG TORCH LINER.....	46
CHANGING THE MIG TORCH LINER (ALUMINIUM).....	48

STICK SETUP

SETUP FOR STICK (MMA) WELDING.....	52
MMA (STICK) WELDING GUIDE.....	55

TIG SETUP

SETUP FOR TIG.....	57
AC TIG WELDING GUIDE.....	60
DC TIG WELDING GUIDE.....	63

SPARES & TROUBLESHOOTING

TORCH BREAKDOWN & SPARES.....	68
MIG DRIVE ROLLERS.....	70
FAQ & TROUBLESHOOTING.....	71

Welding and cutting equipment can be dangerous to both the operator and people in or near the surrounding working area if the equipment is not correctly operated. Equipment must only be used under the strict and comprehensive observance of all relevant safety regulations.

Read and understand this instruction manual carefully before the installation and operation of this equipment.

Machine Operating Safety

- Do not switch the function modes while the machine is operating. Switching of the function modes during welding can damage the machine. Damage caused in this manner will not be covered under warranty.
- Disconnect the electrode-holder cable from the machine before switching on the machine, to avoid arcing should the electrode be in contact with the workpiece.
- Operators should be trained and or qualified.



Electric shock: It can kill. Touching live electrical parts can cause fatal shocks or severe burns. The electrode and work circuit is electrically live whenever the output is on. The input power circuit and internal machine circuits are also live when power is on. In MIG/MAG welding, the wire, drive rollers, wire feed housing, and all metal parts touching the welding wire are electrically live. Incorrectly installed or improperly grounded equipment is dangerous.

- Connect the primary input cable, according to Australian and New Zealand standards and regulations.
- Avoid all contact with live electrical parts of the welding/cutting circuit, electrodes and wires with bare hands.
- The operator must wear dry welding gloves while he/she performs the welding/cutting task.
- The operator should keep the workpiece insulated from himself/herself.
- Keep cords dry, free of oil and grease, and protected from hot metal and sparks.
- Frequently inspect input power cable for wear and tear, replace the cable immediately if damaged, bare wiring is dangerous and can kill.
- Do not use damaged, undersized, or badly joined cables.
- Do not weld in the rain.
- Do not drape cables over your body.
- We recommend (RCD) safety switch is used with this equipment to detect any leakage of current to earth.

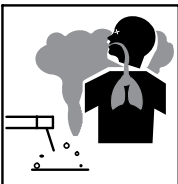

Fumes and gases are dangerous. Smoke and gas generated while welding or cutting can be harmful to people's health. Welding produces fumes and gases. Breathing these fumes and gases can be hazardous to your health.

- Do not breathe the smoke and gas generated while welding or cutting, keep your head out of the fumes.
- Keep the working area well ventilated, use fume extraction or ventilation to remove welding/cutting fumes and gases.
- In confined or heavy fume environments always wear an approved air-supplied respirator.
- Welding/cutting fumes and gases can displace air and lower the oxygen level, causing injury or death. Be sure the breathing air is safe.
- Do not weld/cut in locations near degreasing, cleaning, or spraying operations. The heat and rays of the arc can react with vapours to form highly toxic and irritating gases.
- Materials such as galvanised, lead, or cadmium plated steel, containing elements that can give off toxic fumes when welded/cut. Do not weld/cut these materials unless the area is very well ventilated, and or wearing an air-supplied respirator.

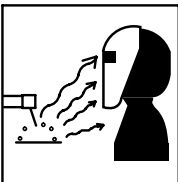

Arc rays: harmful to people's eyes and skin. Arc rays from the welding/cutting process produce intense visible and invisible ultraviolet and infrared rays that can burn eyes and skin.

- Always wear a welding helmet with the correct shade of filter lens and suitable protective clothing, including welding gloves while the welding/cutting operation is performed.
- Measures should be taken to protect people in or near the surrounding working area. Use protective screens or barriers to protect others from flash, glare and sparks; warn others not to watch the arc.



Fire hazard. Welding/cutting on closed containers, such as tanks, drums, or pipes, can cause them to explode. Flying sparks from the welding/cutting arc, hot workpiece, and hot equipment can cause fires and burns. Accidental contact of the electrode to metal objects can cause sparks, explosion, overheating, or fire. Check and be sure the area is safe before doing any welding/cutting.

- The welding/cutting sparks & spatter may cause fire, therefore remove any flammable materials well away from the working area. Cover flammable materials and containers with approved covers if unable to be moved from the welding/cutting area.
- Do not weld/cut on closed containers such as tanks, drums, or pipes, unless they are correctly prepared according to the required Safety Standards to ensure that flammable or toxic vapours and substances are totally removed, these can cause an explosion even though the vessel has been "cleaned". Vent hollow castings or containers before heating, cutting or welding. They may explode.
- Do not weld/cut where the atmosphere may contain flammable dust, gas, or liquid vapours (such as petrol)
- Have a fire extinguisher nearby and know how to use it. Be alert that welding/cutting sparks and hot materials from welding/cutting can easily go through small cracks and openings to adjacent areas. Be aware that welding/cutting on a ceiling, floor, bulkhead, or partition can cause a fire on the hidden side.

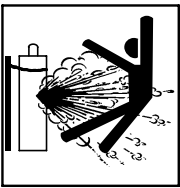

Gas Cylinders. Shielding gas cylinders contain gas under high pressure. If damaged, a cylinder can explode. Because gas cylinders usually are part of the welding/cutting process, be sure to treat them carefully. CYLINDERS can explode if damaged.

- Protect gas cylinders from excessive heat, mechanical shocks, physical damage, slag, open flames, sparks, and arcs.
- Ensure cylinders are held secure and upright to prevent tipping or falling over.
- Never allow the welding/cutting electrode or earth clamp to touch the gas cylinder, do not drape welding cables over the cylinder.
- Never weld/cut on a pressurised gas cylinder, it will explode and kill you.
- Open the cylinder valve slowly and turn your face away from the cylinder outlet valve and gas regulator.



Gas build-up. The build-up of gas can cause a toxic environment, deplete the oxygen content in the air resulting in death or injury. Many gases used in welding/cutting are invisible and odourless.

- Shut off shielding gas supply when not in use.
- Always ventilate confined spaces or use approved air-supplied respirator.

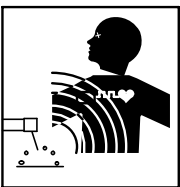

Electronic magnetic fields. MAGNETIC FIELDS can affect Implanted Medical Devices.

- Wearers of Pacemakers and other Implanted Medical Devices should keep away.
- Implanted Medical Device wearers should consult their doctor and the device manufacturer before going near any electric welding, cutting or heating operation.



Noise can damage hearing. Noise from some processes or equipment can damage hearing.

- Wear approved ear protection if noise level is high.



Hot parts. Items being welded/cut generate and hold high heat and can cause severe burns.

- Do not touch hot parts with bare hands. Allow a cooling period before working on the welding/cutting gun. Use insulated welding gloves and clothing to handle hot parts and prevent burns.

CAUTION

1. Working Environment.

- i. The environment in which this welding/cutting equipment is installed must be free of grinding dust, corrosive chemicals, flammable gas or materials etc., and at no more than a maximum of 80% humidity.
- ii. When using the machine outdoors, protect the machine from direct sunlight, rainwater and snow, etc.; the temperature of the working environment should be maintained within -10°C to +40°C.
- iii. Keep this equipment 30cm distant from the wall.
- iv. Ensure the working environment is well ventilated.

2. Safety Tips.

- i. **Ventilation:** This equipment is small-sized, compact in structure, and of excellent performance in amperage output. The fan is used to dissipate heat generated by this equipment during the welding/cutting operation. Important: Maintain good ventilation of the louvres of this equipment. The minimum distance between this equipment and any other objects in or near the working area should be 30 cm. Good ventilation is of critical importance for the normal performance and service life of this equipment.
- ii. **Thermal Overload Protection:** Should the machine be used to an excessive level, or in a high-temperature environment, poorly ventilated area or if the fan malfunctions the Thermal Overload Switch will be activated, and the machine will cease to operate. Under this circumstance, leave the machine switched on to keep the built-in fan working to bring down the temperature inside the equipment. The machine will be ready for use again when the internal temperature reaches a safe level.
- iii. **Over-Voltage Supply:** Regarding the power supply voltage range of the machine, please refer to the "Main parameter" table. This equipment is of automatic voltage compensation, which enables the maintaining of the voltage range within the given range. In case that the voltage of input power supply amperage exceeds the stipulated value, it is possible to cause damage to the components of this equipment. Please ensure your primary power supply is correct.
- iv. Do not come into contact with the output terminals while the machine is in operation. An electric shock may occur.

MAINTENANCE

Exposure to extremely dusty, damp, or corrosive air is damaging to the welding/cutting machine. To prevent any possible failure or fault of this welding/cutting equipment, clean the dust at regular intervals with clean and dry compressed air of required pressure.

Please note that: lack of maintenance can result in the cancellation of the guarantee; the guarantee of this welding/cutting equipment will be void if the machine has been modified, attempt to take apart the machine or open the factory-made sealing of the machine without the consent of an authorized representative of the manufacturer.

TROUBLESHOOTING

Caution: Only qualified technicians are authorized to undertake the repair of this welding/cutting equipment. For your safety and to avoid Electrical Shock, please observe all safety notes and precautions detailed in this manual.

ATTENTION! - CHECK FOR GAS LEAKAGE

At initial set up and at regular intervals we recommend to check for gas leakage

Recommended procedure is as follows:

- 1.** Connect the regulator and gas hose assembly and tighten all connectors and clamps.
- 2.** Slowly open the cylinder valve.
- 3.** Set the flow rate on the regulator to approximately 8-10 L/min.
- 4.** Close the cylinder valve and pay attention to the needle indicator of the contents pressure gauge on the regulator, if the needle drops away towards zero there is a gas leak. Sometimes a gas leak can be slow and to identify it will require leaving the gas pressure in the regulator and line for an extended time period. In this situation it is recommended to open the cylinder valve, set the flow rate to 8-10 L/min, close the cylinder valve and check after a minimum of 15 minutes.
- 5.** If there is a gas loss then check all connectors and clamps for leakage by brushing or spraying with soapy water, bubbles will appear at the leakage point.
- 6.** Tighten clamps or fittings to eliminate gas leakage.

IMPORTANT! - We strongly recommend that you check for gas leakage prior to operation of your machine. We recommend that you close the cylinder valve when the machine is not in use.

Welding Guns Of Australia PTY LTD, authorised representatives or agents of Welding Guns Of Australia PTY LTD will not be liable or responsible for the loss of any gas.

RAZOR MULTI 230 AC/DC MIG/TIG/STICK Welder

Key Features:

- 4-in-1 Multi-process
- AC/DC High-Frequency TIG
- 5" Colour LCD
- Synergic Programs
- Geared Wire Drive
- Power Factor Correction

3 YEAR
PRODUCT
WARRANTY



TECHNICAL DATA

SKU	U11004K
PRIMARY INPUT VOLTAGE	240V Single Phase
SUPPLY PLUG	15 AMP
I _{eff} (A)	9.4 / 15
RATED OUTPUT	25A/15.3V-200A/24V (10A) 25A/15.3V-230A/25.5V (15A)
PROTECTION CLASS	IP21
INSULATION CLASS	H
MINIMUM GENERATOR (kVA)	8.5 (10A) / 10 (15A)
DINSE CONNECTOR	35/50
STANDARD	AS/NZ60974-1
WELDS	Mild Steel, Stainless Steel, Cast Iron, Silicon Bronze, Aluminium, Copper
WARRANTY (Years)	3

MIG SPECIFICATIONS

MIG WELDING CURRENT RANGE	25-200A (10A) / 25-230A (15A)
MIG DUTY CYCLE @ 40°C	10% @ 200A, 60% @ 81A, 100% @ 63A (10A) 25% @ 230A, 60% @ 187A, 100% @ 145A (15A)
MIG WIRE SIZE RANGE	0.6-1.0mm
MIG WIRE SPOOL SIZE	1kg / 5kg
MIG WELDING THICKNESS RANGE	1-10mm
DRIVE ROLLER SIZE	30/22

TIG SPECIFICATIONS

TIG FUNCTION TYPE	AC/DC High-Frequency
TIG WELDING CURRENT RANGE	10-230A
TIG DUTY CYCLE @ 40°C	25% @ 200A, 60% @ 130A, 100% @ 100A (10A) 35% @ 230A, 60% @ 175A, 100% @ 136A (15A)
TIG WELDING THICKNESS RANGE	1-8mm

STICK SPECIFICATIONS

STICK WELDING CURRENT RANGE	10-200A
STICK DUTY CYCLE @ 40°C	10% @ 200A, 60% @ 81A, 100% @ 63A (10A) 25% @ 200A, 60% @ 130A, 100% @ 100A (15A)
STICK ELECTRODE RANGE	2.5-4.0mm
STICK WELDING THICKNESS RANGE	2-12mm

SIZE & WEIGHT

DIMENSIONS (mm)	660x210x330mm
WEIGHT (kg)	20kg

MACHINE FEATURES

WIRE DRIVE	Geared
VRD	Yes
SYNERGIC PROGRAMS	Yes
BURNBACK ADJUSTMENT	Yes
THERMAL OVERLOAD PROTECTION	Yes
POWER FACTOR CORRECTION (PFC)	Yes

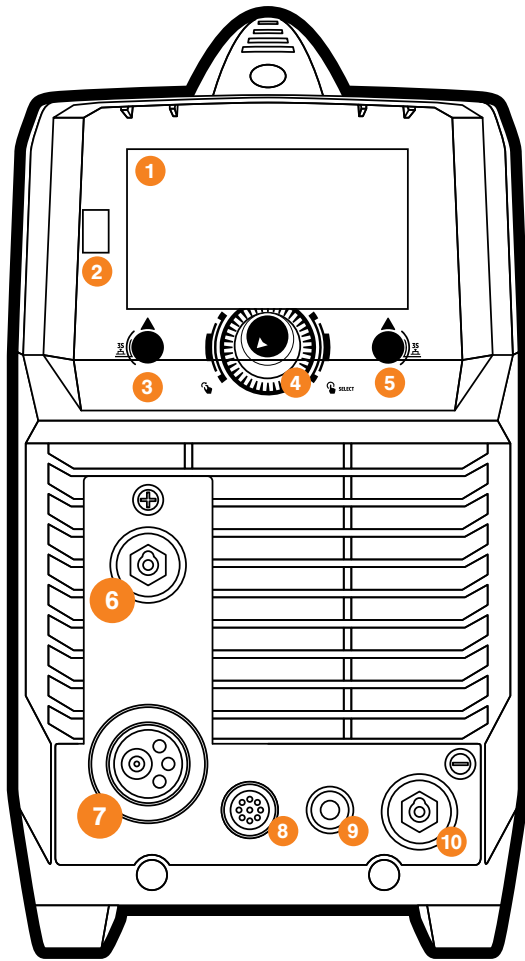

Front Panel Layout

1. Digital Screen
2. USB Port
3. Left Action Button
4. Selector / Scroll Knob
5. Right Action Button
6. "+" Output Terminal
7. Euro Connection
8. 9-Pin Socket
9. Gas Outlet
10. "-" Output Terminal

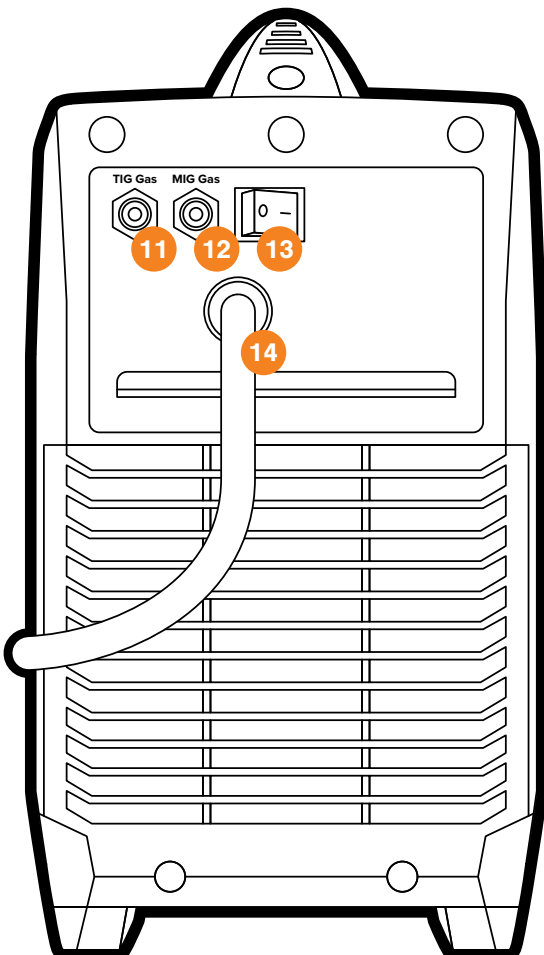

Rear Panel Layout

11. TIG Gas Inlet
12. MIG Gas Inlet
13. On/Off Switch
14. Power Cable

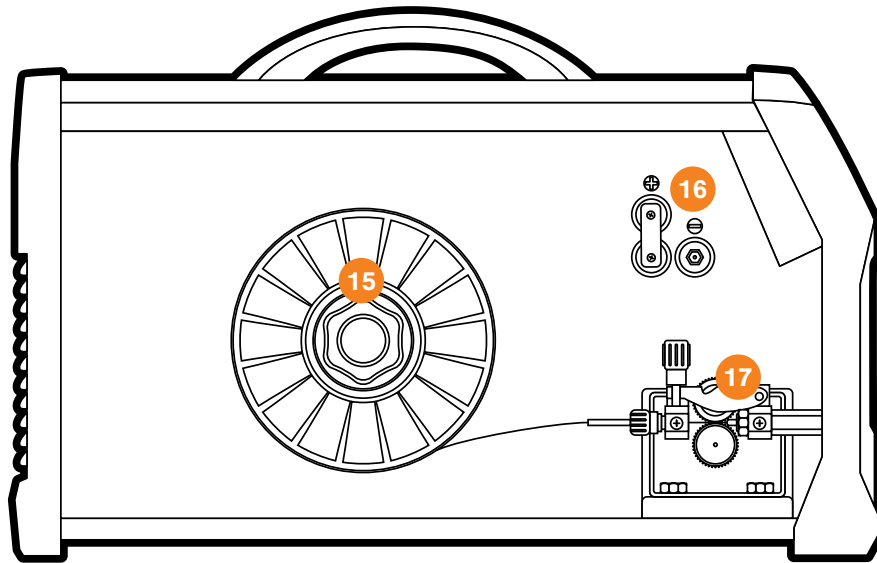

Interior Layout

- 15.** Wire Feeding Spool Holder
- 16.** Polarity Selector
- 17.** Geared Wire Feeder

WHAT'S IN THE BOX

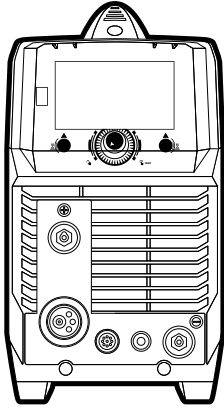

RAZOR MULTI 230 AC/DC Welder

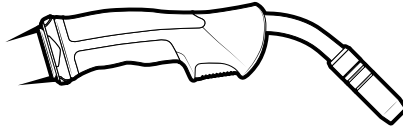

4m SB24 MIG Torch

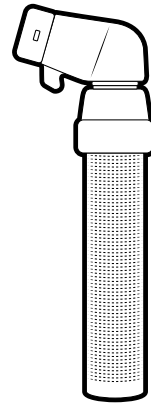

4m Electrode Holder

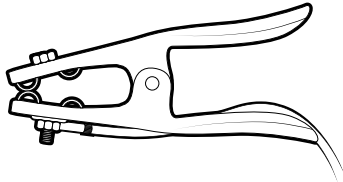

4m 300 AMP Earth Clamp

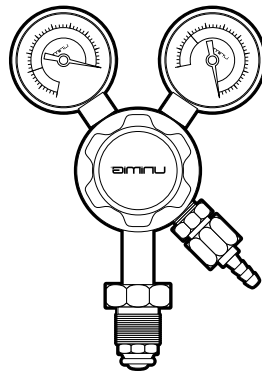

Twin Gauge Argon Regulator

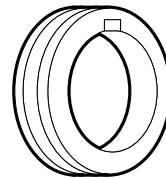

Includes:

- 0.8-0.9mm "V GROOVE" 30/22
- 0.8-0.9mm "F GROOVE" 30/22
- 1.0-1.2mm "U GROOVE" 30/22

Drive Rollers

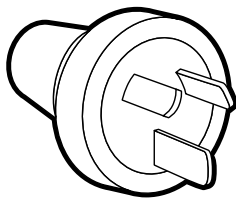

15 AMP Plug (Fitted)

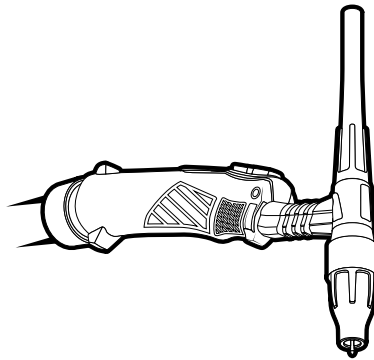

4m T2 TIG Torch



Operating Manual

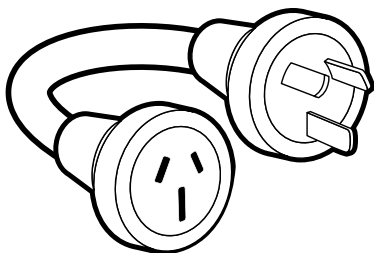

15 AMP to 10 AMP Conversion Lead



1. Main Control Knob

- i. **Turn** this knob for digital screen navigation and cycling through menu options. If a menu item is active, turning this knob will adjust the item value.
- ii. **Press** this knob in order to confirm actions between the weld screen and the weld menu parameters. Pressing this knob also cycles through weld cycle parameters.

2. Left Action Button

- i. **Press** the Left Action Button to initiate the action in **2a**.
- ii. **Press and hold for 3s** to initiate the action in **2b**.

3. Right Action Button

- i. **Press** the Right Action Button to initiate the action in **3a**.
- ii. **Press and hold for 3s** to initiate the action in **3b**.

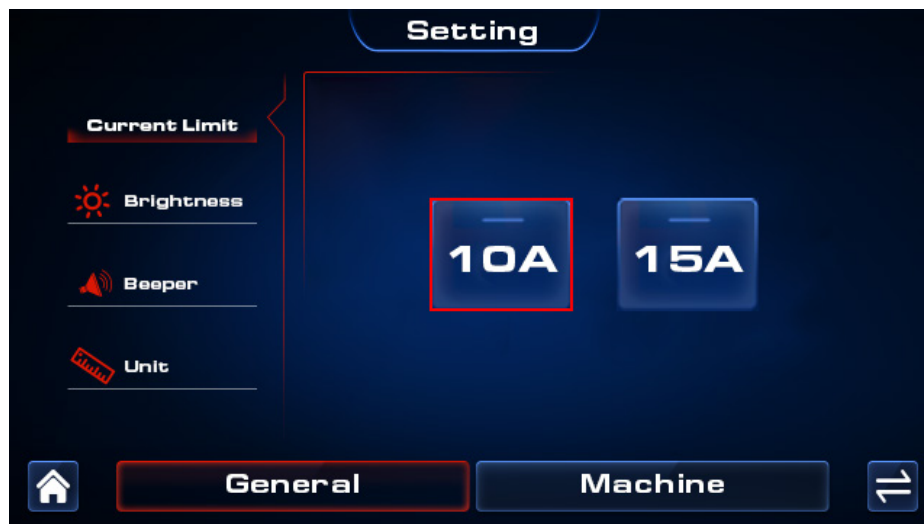

Select the **Settings** menu from the Home Screen. Press the **Right Action Button** to cycle between the **General Settings** and **Machine Settings** menus.

General Settings

1. Current Limit

Switch between 10A and 15A modes. **When in 15A mode, ensure that you have disconnected the 15A to 10A conversion lead.**

2. Brightness

Adjust the brightness of the LCD screen.

3. Beeper

Turn the beeper off or on. If turned on, the machine will beep every time the **Main Control Knob** is turned or an action button is pressed.

4. Unit

Choose Metric or Imperial measurements.

5. Information

View your machine identification information, including:

- Firmware Version

6. Factory Reset

Restore your machine back to factory settings. After selecting **Factory Settings** you will be prompted to confirm whether or not you wish to proceed with the action.

7. Program Update

Update firmware via USB.

Machine Settings

8. Fan

Change fan between Normal and Smart modes.

- **Normal:** Fan runs constantly
- **Smart:** Fan runs only when machine requires cooling.

9. Wireless Foot Control

Connect to Wireless Foot Control. To connect to a wireless foot control:

- Select the Wireless Foot Control option
- Turn your Wireless Foot Control ON
- Press down on the Foot Control pedal

10. Wire Retract

Turn the Wire Retract feature off or on. Wire Retract aids in arc ignition when welding aluminium by retracting the wire feed when arc ignition is detected.

11. Remote Control

Turn the remote control off or on for torch controls, wireless and wired footpedal.

DIGITAL SCREEN - MMA (STICK)

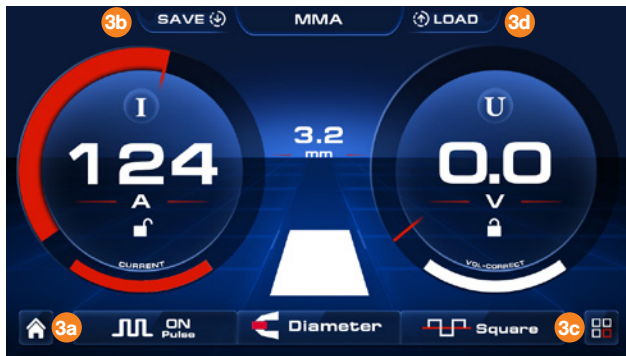

1. MMA Settings
2. Advanced MMA Settings
3. Button Functions

1. MMA Settings

i. Current

ii. Pulse

Turn Pulse off or on. Pulse MMA (STICK) welding helps reduce spatter, improves heat control and allows for an easier removal of slag. It also improves the speed and efficiency of vertical up welds by eliminating the use of the “Christmas Tree” technique, while still maintaining root fusion.

iii. Waveform

Select DC or AC waveform.

2. Advanced MMA (STICK) Settings

DC/AC

Setting	Values	Description
Hot Start	0-100%	Hot Start provides an initial burst of current, improving the arc ignition and greatly reducing the chance of sticking.
Hot Start Time	0.5-5s	Set how long Hot Start runs for.
Welding Amp	10-200A	Set the peak welding current.
Arc Force	0-100	Arc Force helps to keep the arc stabilised throughout the weld, by detecting any short circuits and increasing the peak current to prevent the arc cutting out or electrode sticking.

DC/AC Pulse

Setting	Values	Description
Hot Start	0-100%	Hot Start provides an initial burst of current, improving the arc ignition and greatly reducing the chance of sticking.
Hot Start Time	0.5-5s	Set how long Hot Start runs for.
Peak Amp	10-200A	Set the peak welding current.
Base Amp	10-200A	Set the base current of the pulse cycle.
Frequency	0.5-400Hz	Set the number of pulses per second.
Pulse Width	5-95%	Set the percentage of the pulse cycle spent in peak amp.

3. Button Functions

3a. Home

3b. Save Job (Hold for 3s)

3c. Advanced MMA Settings Menu

3d. Load Job (Hold for 3s)

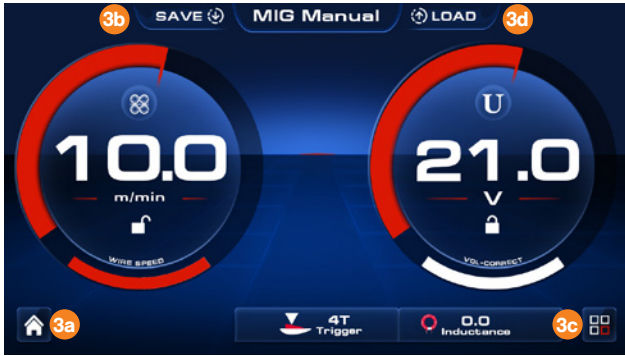

1. **Standard MIG Settings**
2. **Advanced MIG Settings**
3. **Button Functions**

1. Standard MIG Settings

- i. **Wire Speed**
- ii. **Voltage**
- iii. **Torch Trigger**

Select the desired Torch Trigger.

Torch Cycle	Description
2T	2T (two touch) means you will need to hold the trigger down on your MIG torch while you weld.
4T	4T (four touch) means you will only need to press the trigger once to ignite the arc and the torch will continue to weld until you press it again to turn it off.
SPOT	SPOT mode is consecutive and evenly timed arcs that work well if you want perfectly even tacks and small welds.

iv. Inductance

By changing the frequency of your short circuit MIG welds with the Inductance controls, you can choose your preferred arc characteristics on every weld. A low inductance setting will give you narrow, fast freezing weld with more spatter. A high inductance setting will give you a fluid weld pool with minimal spatter.

2. Advanced MIG Settings

2T/4T/SPOT

Setting	Values	Description
Pre Flow	0-20s	Set how long you would like your gas to flow before the arc ignites.
Creep Start	0-10	Set the amount of Creep Start to allow for smoother arc ignition when welding at higher welding speeds.
Welding Volts	As Selected	Set the peak welding volts.
Burn Back	0-10	Set how far the wire will burn back once the torch trigger has been released.
Post Flow	0-20s	Set how long you would like your gas to flow after the arc ends.
Spot Time	0.5 - 25s	Set the length of time to run the SPOT function.
Spot Pause Timer	0.5 - 20s	Set the length of time for the SPOT function to pause in between welds. If you hold down the torch trigger, the welder will continue to run according to your Spot Timer and your Spot Pause Time.

3. Button Functions

3a. Home

3b. Save Job (Hold for 3s)

3c. Advanced MIG Settings Menu

3d. Load Job (Hold for 3s)

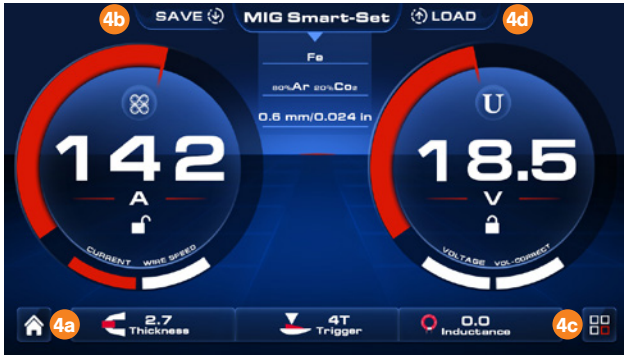

1. MIG Smart-Set Setup
2. Standard MIG Settings
3. Advanced MIG Settings
4. Button Functions

1. MIG Smart-Set Setup

i. Joint Type

Select the desired joint type.

- Butt Joint
- Fillet Joint
- Lap Joint

ii. Wire / Gas

Select the desired wire and gas mixture.

	Wire Diameter					Gas Mixture			
	0.6mm	0.8mm	0.9mm	1.0mm	1.2mm	80/20	5/2	98/2	Ar
Mild Steel	✓	✓	✓			✓	✓		
Flux-Cored		✓	✓						
Stainless Steel		✓	✓					✓	
Aluminium				✓	✓				✓

2. Standard MIG Settings

i. Current / Wire Speed Correction

ii. Voltage Correction

iii. Torch Trigger

Select the desired Torch Trigger.

Torch Cycle	Description
2T	2T (two touch) means you will need to hold the trigger down on your MIG torch while you weld.
S2T	S2T uses the same trigger logic as 2T, but with added advanced weld cycle features, such as Start Current and Crater Control (Arc End settings).
4T	4T (four touch) means you will only need to press the trigger once to ignite the arc and the torch will continue to weld until you press it again to turn it off.
S4T	S4T uses the same trigger logic as 4T, but with added advanced weld cycle features, such as Start Current and Crater Control (Arc End settings).
SPOT	SPOT mode is consecutive and evenly timed arcs that work well if you want perfectly even tacks and small welds.

iv. Thickness

v. Inductance

By changing the frequency of your short circuit MIG welds with the Inductance controls, you can choose your preferred arc characteristics on every weld. A low inductance setting will give you a narrow, fast freezing weld with more spatter. A high inductance setting will give you a fluid weld pool with minimal spatter.

3. Advanced MIG Settings

2T/4T/SPOT

Setting	Values	Description
Pre Flow	0-20s	Set how long you would like your gas to flow before the arc ignites.
Creep Start	0-10	Set the amount of Creep Start to allow for smoother arc ignition when welding at higher welding speeds.
Welding Amp		Set the peak welding current.
Burn Back	0-10	Set how far the wire will burn back once the torch trigger has been released.
Post Flow	0-20s	Set how long you would like your gas to flow after the arc ends.
Spot Timer	0.5 - 25s	Set the length of time to run the SPOT function.
Spot Pause Timer	0.5 - 20s	Set the length of time for the SPOT function to pause in between welds. If you hold down the torch trigger, the welder will continue to run according to your Spot Timer and your Spot Pause Time.

S2T

Setting	Values	Description
Pre Flow	0-20s	Set how long you would like your gas to flow before the arc ignites.
Creep Start	0-10	Set the amount of Creep Start to allow for smoother arc ignition when welding at higher welding speeds.
Arc Start %	1-200%	Set the Arc Start % to adjust how hot your weld will start.
Arc Start Time	0-20s	Set how long the Arc Start will run.
Welding Amp		Set the peak welding current.
Arc End Time	0-20s	Set how long the Arc End will run.
Arc End %	1-200%	Set the Arc End % to adjust how hot your weld will finish.
Burn Back	0-10	Set how far the wire will burn back once the torch trigger has been released.
Post Flow	0-20s	Set how long you would like your gas to flow after the arc ends.

S4T

Setting	Values	Description
Pre Flow	0-20s	Set how long you would like your gas to flow before the arc ignites.
Creep Start	0-10	Set the amount of Creep Start to allow for smoother arc ignition when welding at higher welding speeds.
Arc Start %	1-200%	Set the Arc Start % to adjust how hot your weld will start.
Welding Amp		Set the peak welding current.
Arc End %	1-200%	Set the Arc End % to adjust how hot your weld will finish.
Burn Back	0-10	Set how far the wire will burn back once the torch trigger has been released.
Post Flow	0-20s	Set how long you would like your gas to flow after the arc ends.

4. Button Functions

4a. Home

4b. Save Job (Hold for 3s)

4c. Advanced MIG Settings Menu

4d. Load Job (Hold for 3s)

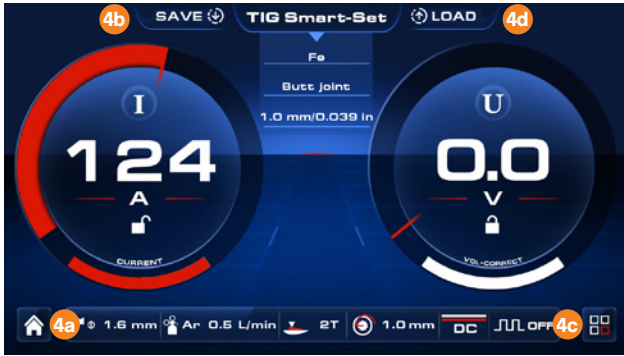

1. TIG Smart-Set Setup
2. Standard TIG Settings
3. Advanced TIG Settings
4. Button Functions

1. TIG Smart-Set Setup

i. Material Type

Select the desired material.

- Mild Steel
- Stainless
- Aluminium

ii. Joint Type

Select the desired joint type.

- Butt Joint
- Fillet Joint
- Lap Joint

iii. Diameter

iv. Thickness

v. Gas

2. Standard TIG Settings

i. Current

ii. Pulse

Turn Pulse off or on.

iii. Torch Trigger

Select the desired Torch Trigger.

Torch Cycle	Description
2T	2T (two touch) means you will need to hold the button down on your High Frequency torch while you weld.
4T	4T (four touch) means you will only need to click the button to ignite the arc and the torch will continue to weld until you click it again to turn it off.
HCT	Heat Control Trigger (HCT) Mode lets you set a base current which you can switch to at any time during a weld by pressing the trigger button. Heat Control Trigger Mode is great for manual heat input control as you go. During the weld cycle push the torch trigger to switch to the HC Base Amp, and push trigger again to return to the Peak Amp. Hold the torch trigger to end the weld cycle.
SPOT	SPOT mode is consecutive and evenly timed arcs that work well if you want perfectly even tacks and small welds.

iv. Waveform

- | | | | |
|-------|----------------------|--------------------|----------------------|
| 1. DC | 2. Square | 5. Sine | 8. Triangular |
| | 3. Square-Sine | 6. Sine-Square | 9. Triangular-Square |
| | 4. Square-Triangular | 7. Sine-Triangular | 10. Triangular-Sine |

3. Advanced TIG Settings

DC

Setting	Values	Description
Pre-Flow	0-20s	Set how long you would like your gas to flow before the arc ignites.
Start Amp	10-230A	Set the starting current when the arc ignites.
Up Slope	0-20s	Set how long it takes for the Start Amp to reach the Peak Amp.
Peak Amp	10-230A	Set the peak welding current.
Down Slope	0-20s	Set how long it takes for the Peak Amp to reach the End Amp.
End Amp	10-230A	Set the End Amp to adjust how hot your weld will finish.
Post-Flow	0-20s	Set how long you would like your gas to flow after the arc ends.
SpotPlus™	0-60s	SpotPlus improves the spot welding mode by applying an adjustable synergic pulsed program. The program speeds up the spot tacking process and is perfect for sheet metal fitups with gaps.
ArcPlus™	0-50A	ArcPlus keeps the volt amps constant by adjusting the welding current proportionally as the arc voltage increases or decreases during a weld. It helps give better puddle control when weaving, reduced heat input and increased side wall fusion.
TackPlus™	0-6Hz	TackPlus allows you to preset a tacking procedure to reduce the time required for tack welding, and also reduces the heat input in the joint between tacks, improving the quality.

AC

Setting	Values	Description
Pre-Flow	0-20s	Set how long you would like your gas to flow before the arc ignites.
Start Amp	10-230A	Set the starting current when the arc ignites.
Up Slope	0-20s	Set how long it takes for the Start Amp to reach the Peak Amp.
Peak Amp	10-230A	Set the peak welding current.
Down Slope	0-20s	Set how long it takes for the Peak Amp to reach the End Amp.
End Amp	10-230A	Set the End Amp to adjust how hot your weld will finish.
Post-Flow	0-20s	Set how long you would like your gas to flow after the arc ends.
Balance	±5	Adjust the AC Balance up to 5% above or below the calculated value.
AC Frequency	50-250Hz	Adjust the frequency of the AC waveform.
Mix AC/DC %	0-80%	Mixed AC/DC welding is the combination of TIG AC and TIG DC- in one weld. Mixed AC/DC gives you faster welding speeds, better penetration, a faster weld puddle on cold workpieces, and allows you to weld on thicker materials.
FusionPlus™	0-80%	FusionPlus is an advanced AC TIG feature that provides greater arc focus at high welding speeds, and provides deep penetration even at low AC frequencies.
Diameter	1.0, 1.6, 2.0, 2.4, 3.2, 4.0	Optimises the welding arc ignition in AC TIG based on the chosen tungsten diameter.

DC Pulse

Setting	Values	Description
Pre-Flow	0-20s	Set how long you would like your gas to flow before the arc ignites.
Start Amp	10-230A	Set the starting current when the arc ignites.
Up Slope	0-20s	Set how long it takes for the Start Amp to reach the Peak Amp.
Peak Amp	10-230A	Set the peak welding current.
Base Amp	10-230A	Set the base current of the pulse cycle.
Pulse Width	5-95%	Set the percentage of the pulse cycle spent in peak amp.
Frequency	0.5-999Hz	Set the number of pulses per second.
Down Slope	0-20s	Set how long it takes for the Peak Amp to reach the End Amp.
End Amp	10-230A	Set the End Amp to adjust how hot your weld will finish.
Post-Flow	0-20s	Set how long you would like your gas to flow after the arc ends.

AC Pulse

Setting	Values	Description
Pre-Flow	0-20s	Set how long you would like your gas to flow before the arc ignites.
Start Amp	10-230A	Set the starting current when the arc ignites.
Up Slope	0-20s	Set how long it takes for the Start Amp to reach the Peak Amp.
Peak Amp	10-230A	Set the peak welding current.
Base Amp	10-230A	Set the base current of the pulse cycle.
Pulse Width	5-95%	Set the percentage of the pulse cycle spent in peak amp.
Frequency	0.5-999Hz	Set the number of pulses per second.
Down Slope	0-20s	Set how long it takes for the Peak Amp to reach the End Amp.
End Amp	10-230A	Set the End Amp to adjust how hot your weld will finish.
Post-Flow	0-20s	Set how long you would like your gas to flow after the arc ends.
Balance	±5	Adjust the AC Balance up to 5% above or below the calculated value.
AC Frequency	50-250Hz	Adjust the frequency of the AC waveform.
Diameter	1.0, 1.6, 2.0, 2.4, 3.2, 4.0	Optimises the welding arc ignition in AC TIG based on the chosen tungsten diameter.

DC Spot

Setting	Values	Description
Pre-Flow	0-20s	Set how long you would like your gas to flow before the arc ignites.
Peak Amp	10-230A	Set the peak welding current.
Down Slope	0-20s	Set how long it takes for the Peak Amp to reach the End Amp.
End Amp	10-230A	Set the End Amp to adjust how hot your weld will finish.
Post-Flow	0-20s	Set how long you would like your gas to flow after the arc ends.
Spot Time	0-10s	Set the length of time to run the SPOT function.
ArcPlus™	0-50A	ArcPlus keeps the volt amps constant by adjusting the welding current proportionally as the arc voltage increases or decreases during a weld. It helps give better puddle control when weaving, reduced heat input and increased side wall fusion.

AC Spot

Setting	Values	Description
Pre-Flow	0-20s	Set how long you would like your gas to flow before the arc ignites.
Peak Amp	10-230A	Set the peak welding current.
Down Slope	0-20s	Set how long it takes for the Peak Amp to reach the End Amp.
End Amp	10-230A	Set the End Amp to adjust how hot your weld will finish.
Post-Flow	0-20s	Set how long you would like your gas to flow after the arc ends.
Balance	±5	Adjust the AC Balance up to 5% above or below the calculated value.
AC Frequency	50-250Hz	Adjust the frequency of the AC waveform.
Spot Time	0-10s	Set the length of time to run the SPOT function.
Diameter	1.0, 1.6, 2.0, 2.4, 3.2, 4.0	Optimises the welding arc ignition in AC TIG based on the chosen tungsten diameter.

DC HCT

Setting	Values	Description
Pre-Flow	0-20s	Set how long you would like your gas to flow before the arc ignites.
Start Amp	10-230A	Set the starting current when the arc ignites.
Up Slope	0-20s	Set how long it takes for the Start Amp to reach the Peak Amp.
Peak Amp	10-230A	Set the peak welding current.
HC Base Amp	10-230A	Set the Base Amp for the Heat Control Trigger.
Down Slope	0-20s	Set how long it takes for the Peak Amp to reach the End Amp.
End Amp	10-230A	Set the End Amp to adjust how hot your weld will finish.
Post-Flow	0-20s	Set how long you would like your gas to flow after the arc ends.

AC HCT

Setting	Values	Description
Pre-Flow	0-20s	Set how long you would like your gas to flow before the arc ignites.
Start Amp	10-230A	Set the starting current when the arc ignites.
Up Slope	0-20s	Set how long it takes for the Start Amp to reach the Peak Amp.
Peak Amp	10-230A	Set the peak welding current.
HC Base Amp	10-230A	Set the Base Amp for the Heat Control Trigger.
Down Slope	0-20s	Set how long it takes for the Peak Amp to reach the End Amp.
End Amp	10-230A	Set the End Amp to adjust how hot your weld will finish.
Post-Flow	0-20s	Set how long you would like your gas to flow after the arc ends.
Balance	±5	Adjust the AC Balance up to 5% above or below the calculated value.
AC Frequency	50-250Hz	Adjust the frequency of the AC waveform.
Diameter	1.0, 1.6, 2.0, 2.4, 3.2, 4.0	Optimises the welding arc ignition in AC TIG based on the chosen tungsten diameter.

4. Button Functions

4a. Home

4b. Save Job (Hold for 3s)

4c. Advanced TIG Settings Menu

4d. Load Job (Hold for 3s)

SETUP FOR MIG (GASLESS)

- 1 Connect the polarity connector to the **negative (-)** connection, unscrew the bolt and move the connector, then screw and tighten in place.

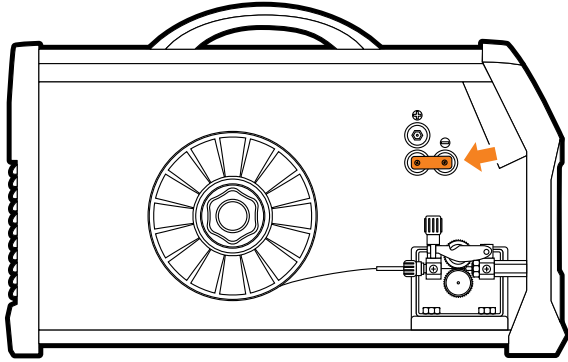

- 2 Connect the earth clamp to the **positive (+)** dinse connection, twist to lock in place.

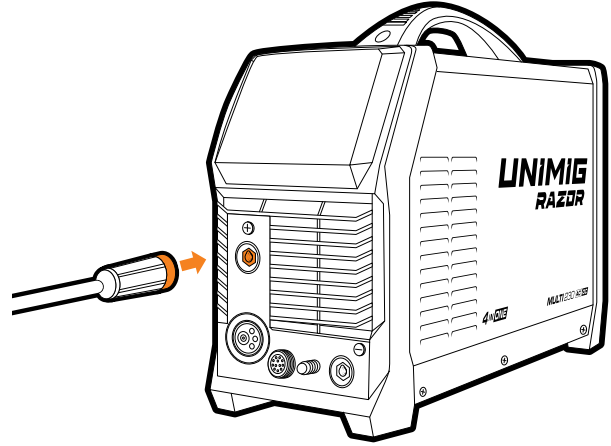

- 3 Connect the MIG torch to the Euro connection and twist end to secure in place.

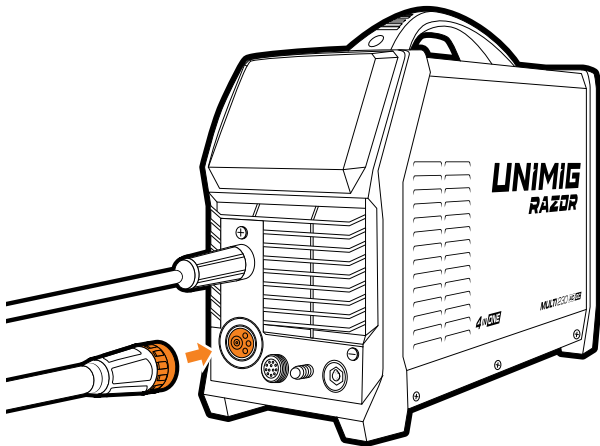

- 4 Connect the plug into a 15 AMP socket, then switch the machine ON.

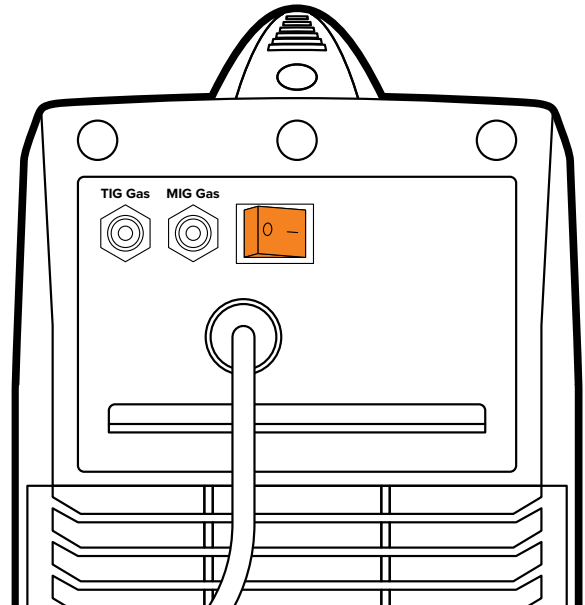

SETUP FOR MIG (GASLESS)

- 5** Pull down the roller tension knob to release the wire drive.

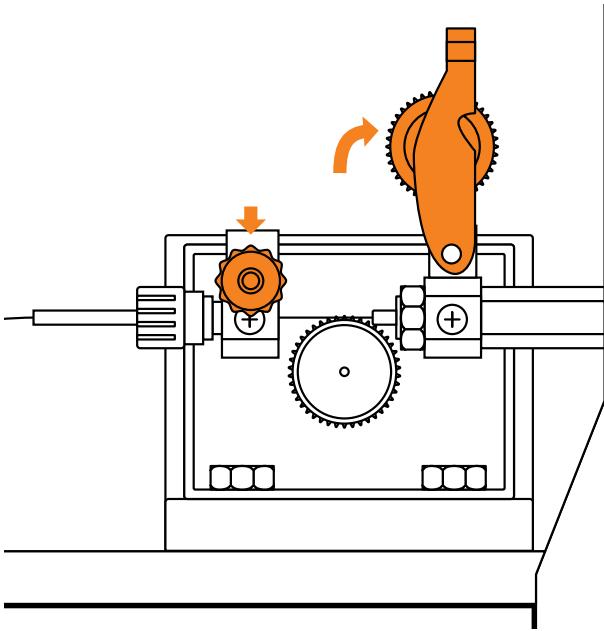

- 6** Unscrew both roller caps.

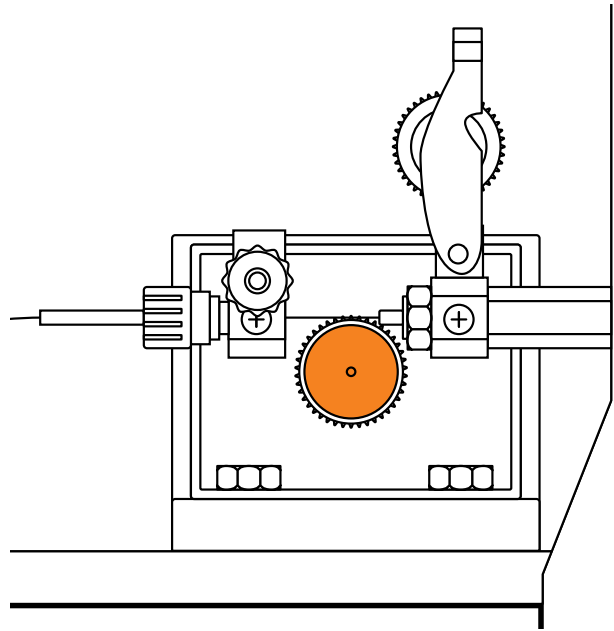

- 7** Ensure you have Knurled (F Groove) drive rollers installed. If not, fit correct rollers and replace the roller covers.

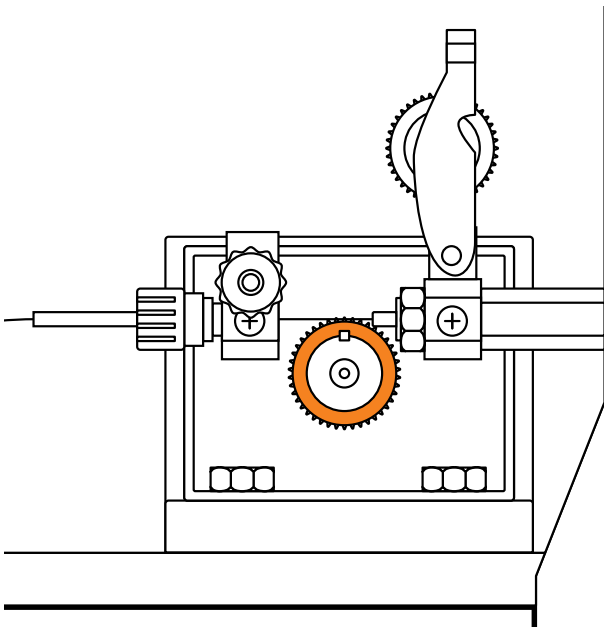

- 8** Unscrew pool retaining nut.

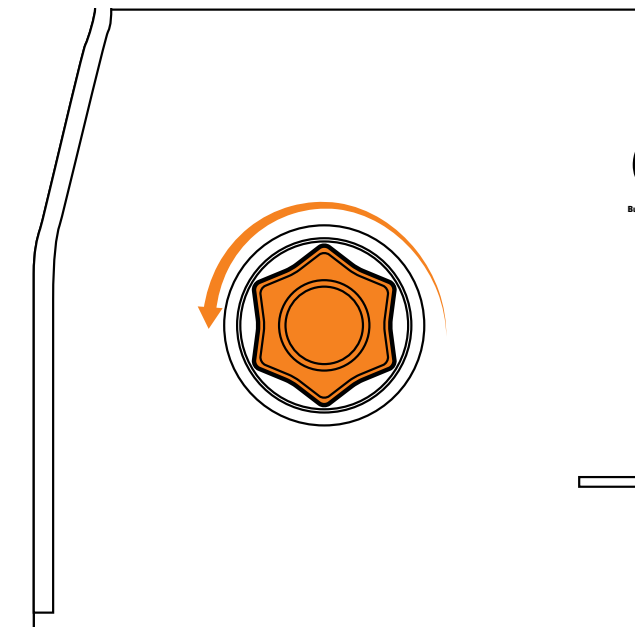

SETUP FOR MIG (GASLESS)

- 9** Place 5kg wire spool onto the spool holder. For 1kg spool, see step 19.

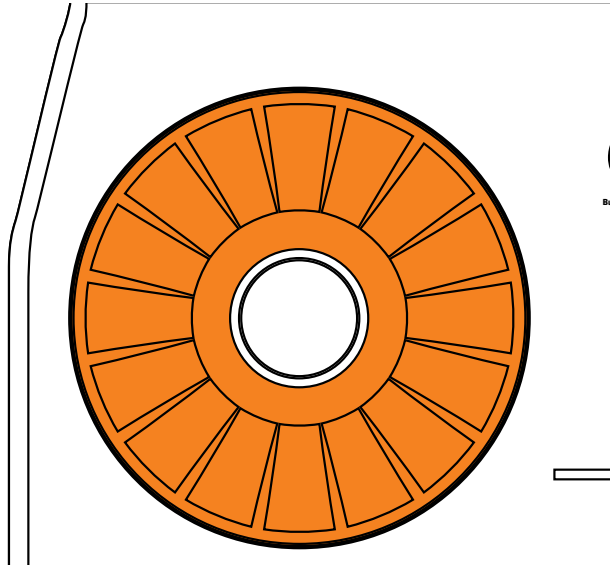

- 10** Tighten spool retaining nut.

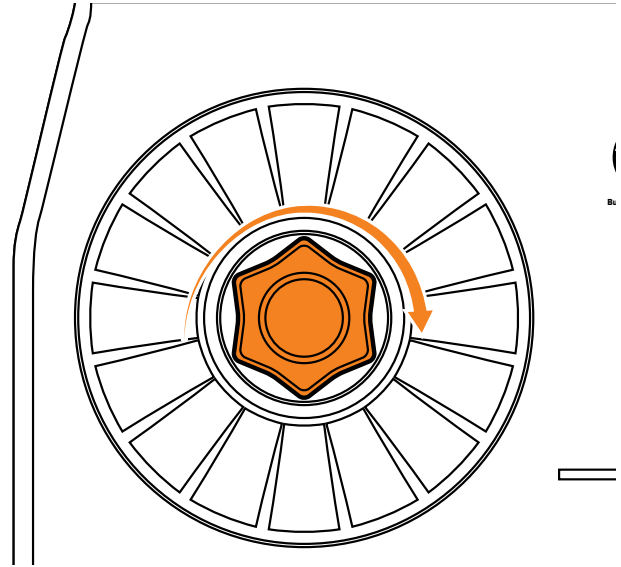

- 11** Feed wire through the inlet guide tube through to the outlet guide tube. Ensure that the wire passes through the roller.

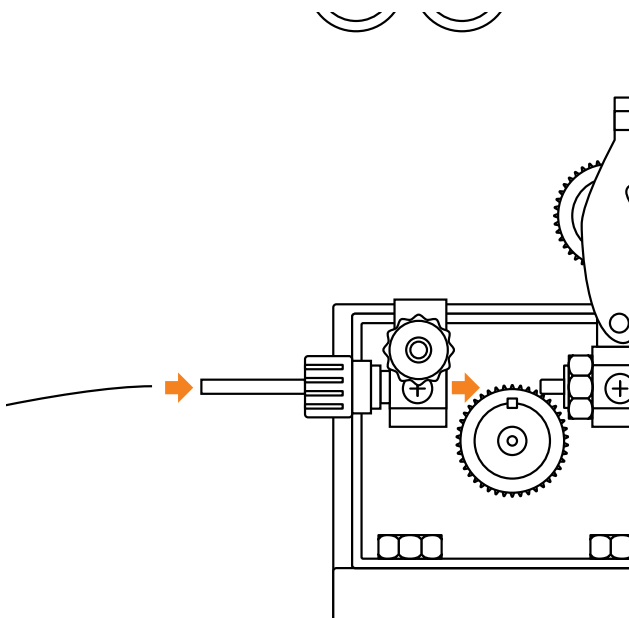

- 12** Lift roller tension knob to lock wire in place. Twist to tighten.

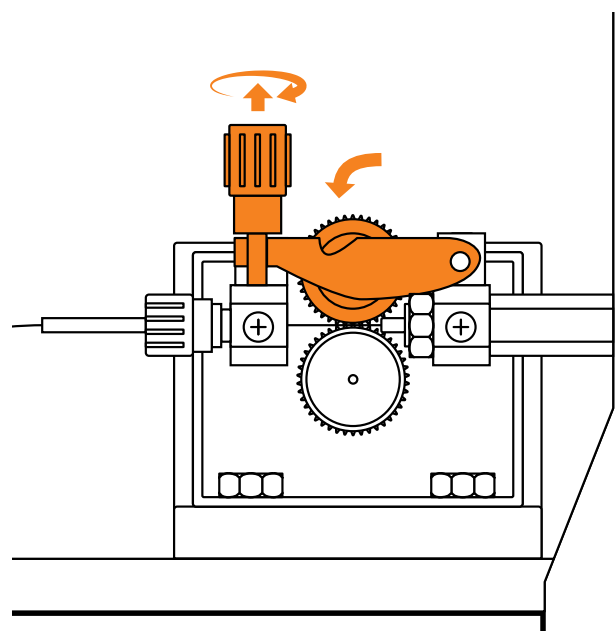

SETUP FOR MIG (GASLESS)

- 13** Remove front end consumables from the MIG torch.

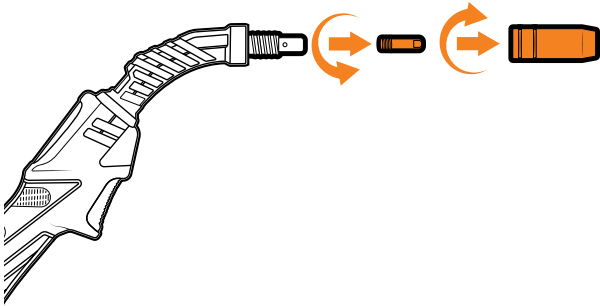

- 14** Hold the torch trigger to feed wire through to the torch. If the wire slips or stops you will need to adjust the roller tension knob.

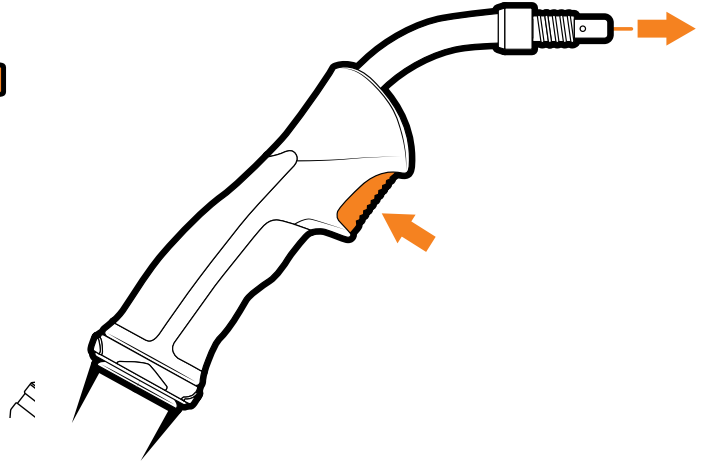

- 15** Replace front end consumables on the MIG torch.

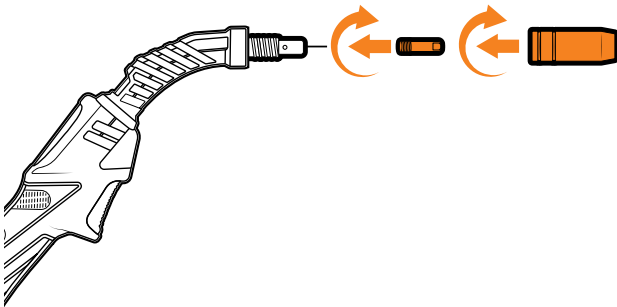

- 16** Connect earth clamp to your workpiece.

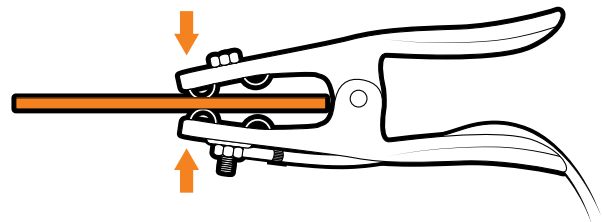

SETUP FOR MIG (GASLESS)

- 17** Set weld parameters on the digital screen. See "Digital Screen - MIG SMART-SET" on page 16.

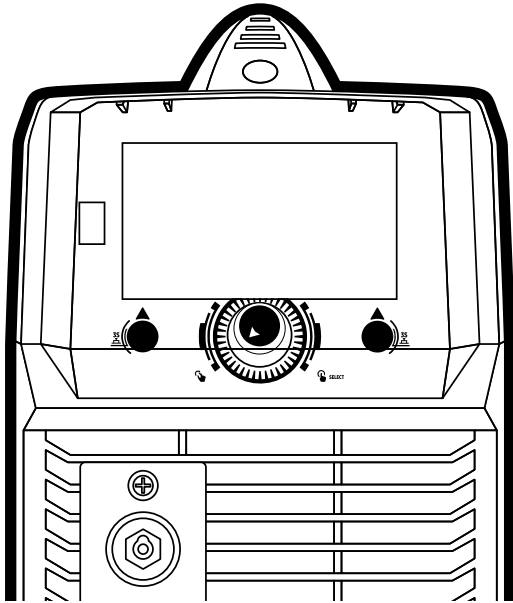

- 18** Line up the torch with your workpiece, then simply pull the trigger to initiate the weld. For gasless MIG, the drag method is recommended for optimum weld quality. Release trigger to end the weld.

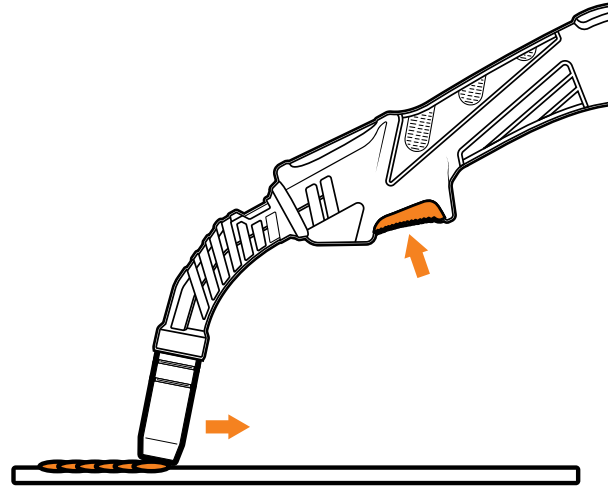

- 19** **For 1kg spool:** After removing spool holder nut, unscrew the 1kg spool bolt located inside the spool holder housing.

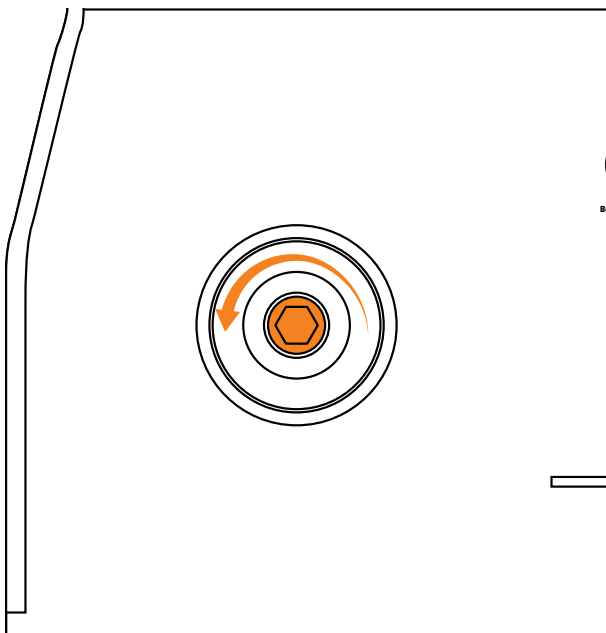

- 20** **For 1kg spool:** Remove spool holder housing and spring. Place 1kg spool housing inside the square hole where the spool housing is removed from. The 1kg housing is found on the inside of the main spool holder housing.

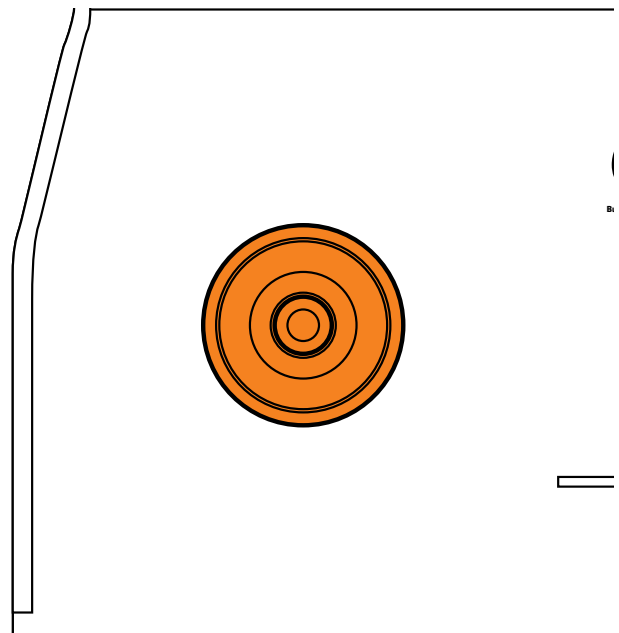

SETUP FOR MIG (GASLESS)

- 21** **For 1kg spool:** Place 1kg spool over 1kg spool housing, then tighten and secure with 1kg spool bolt and nut.

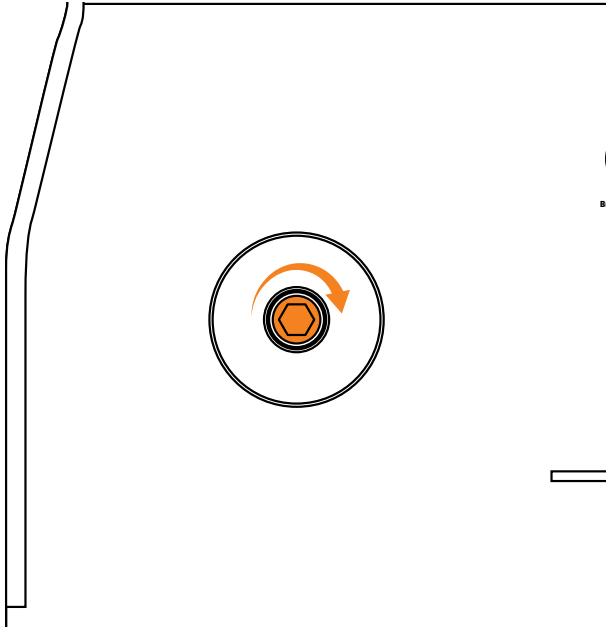

SETUP FOR MIG (GAS-SHIELDED)

- 1 Connect the polarity connector to the **positive (+)** connection, unscrew the bolt and move the connector then screw and tighten in place.

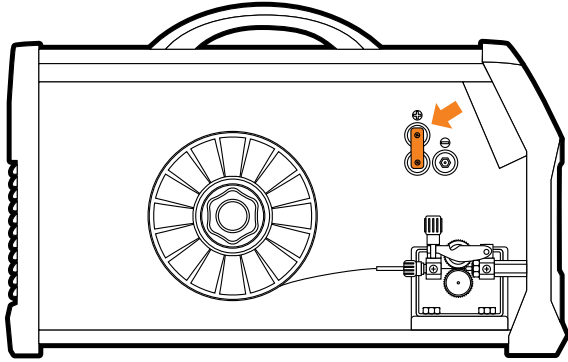

- 2 Connect the earth clamp to the **negative (-)** dinse connection, twist to lock in place.

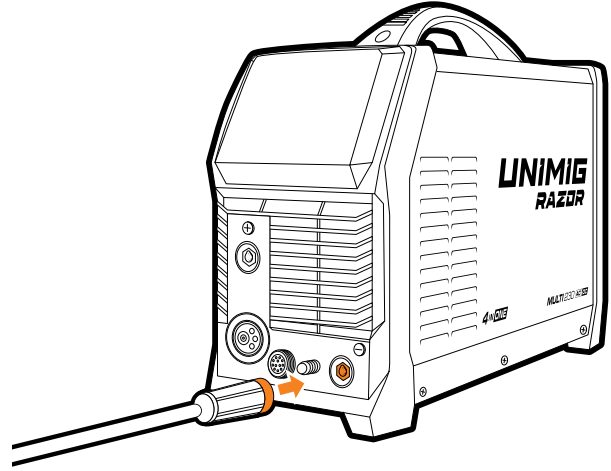

- 3 Connect the MIG torch to the Euro connection and twist end to secure in place.

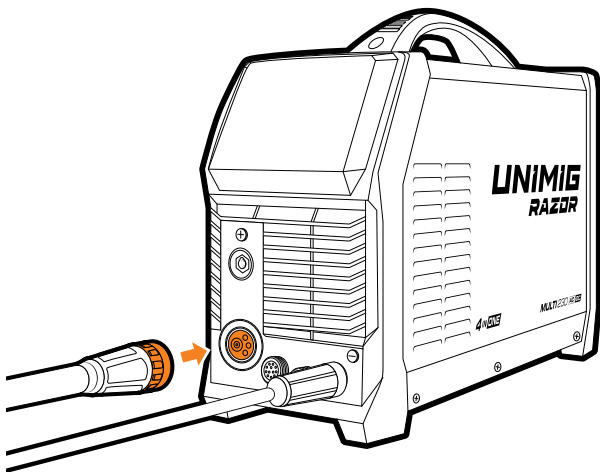

- 4 Connect the plug into a 15 AMP socket, then switch the machine ON.

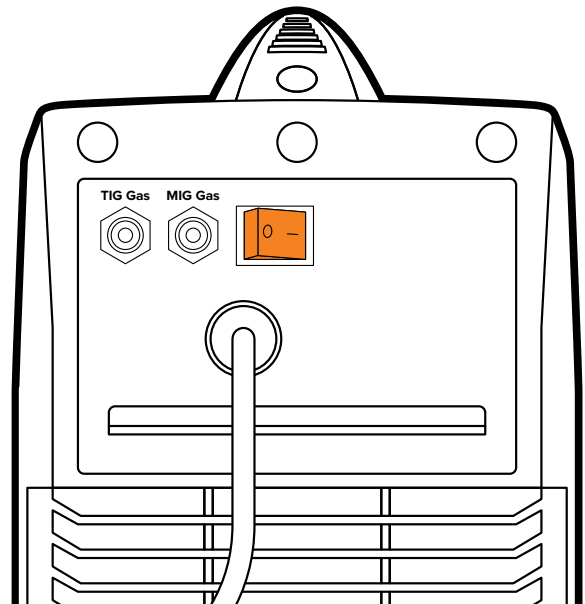

SETUP FOR MIG (GAS-SHIELDED)

- 5** Pull down the roller tension knob to release the wire drive.

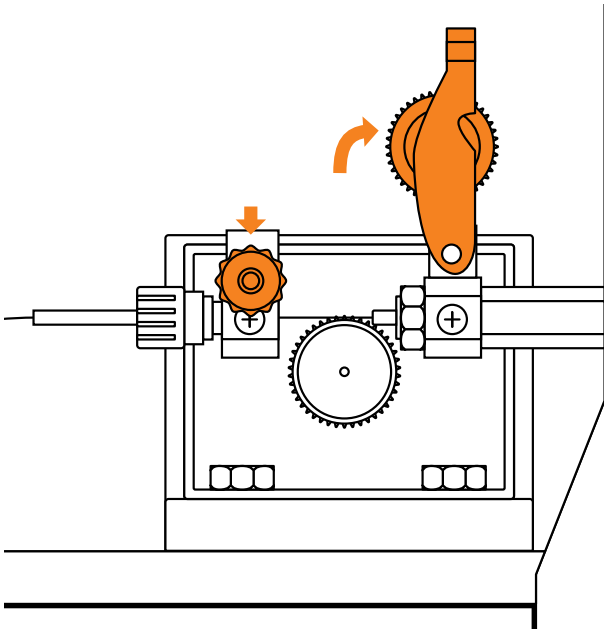

- 6** Unscrew both roller caps.

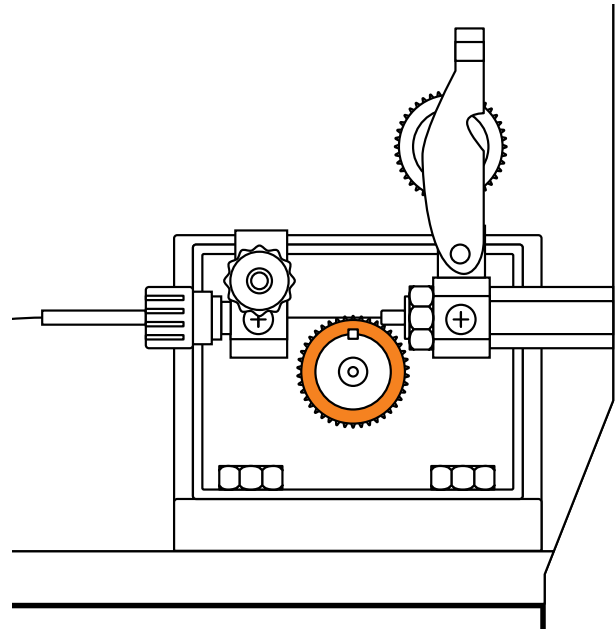

- 7** Ensure you have V Groove drive rollers installed. If not, fit correct rollers and replace the roller covers.

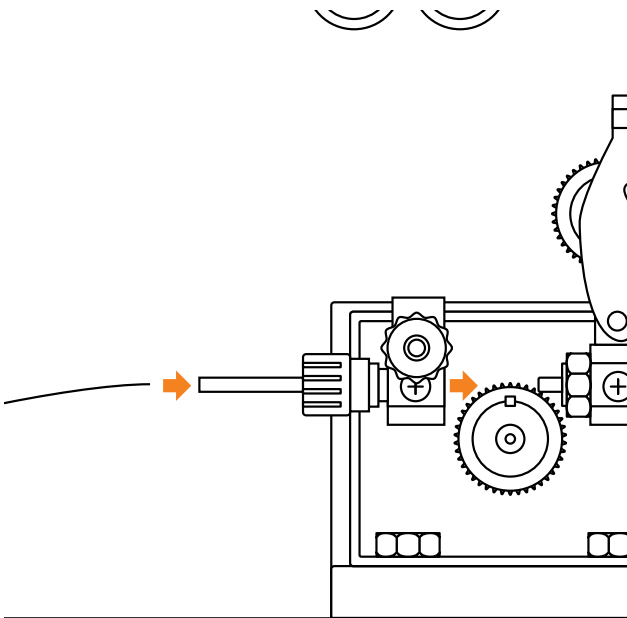

- 8** Unscrew the roller cap.

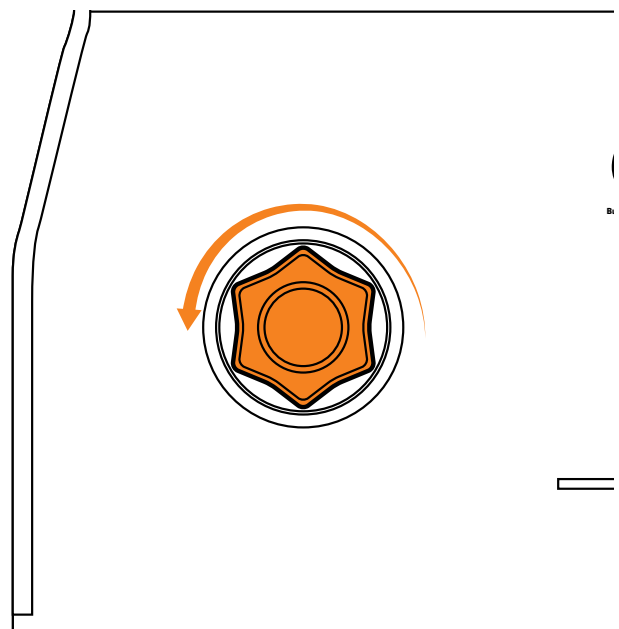

SETUP FOR MIG (GAS-SHIELDED)

9 Place 5kg wire spool onto the spool holder. For 1kg spool, see step 24.

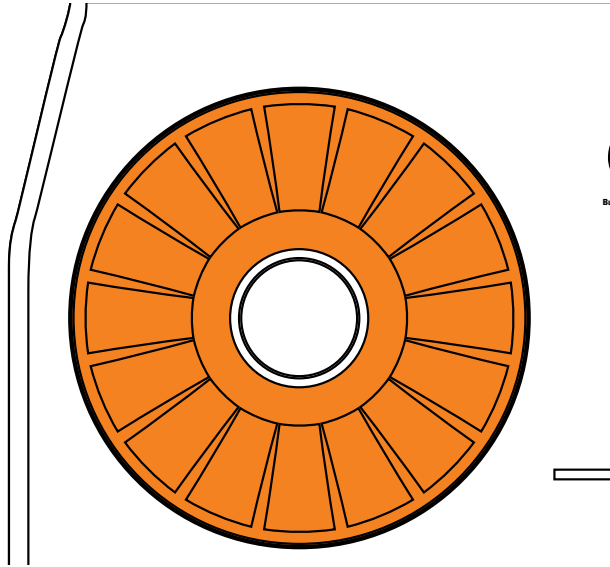

10 Tighten spool retaining nut.

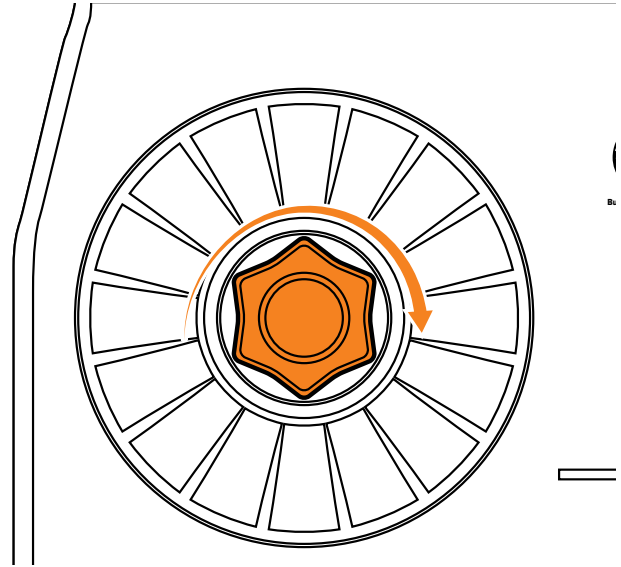

11 Feed wire through the inlet guide tube through to the outlet guide tube. Ensure that the wire passes through the roller.

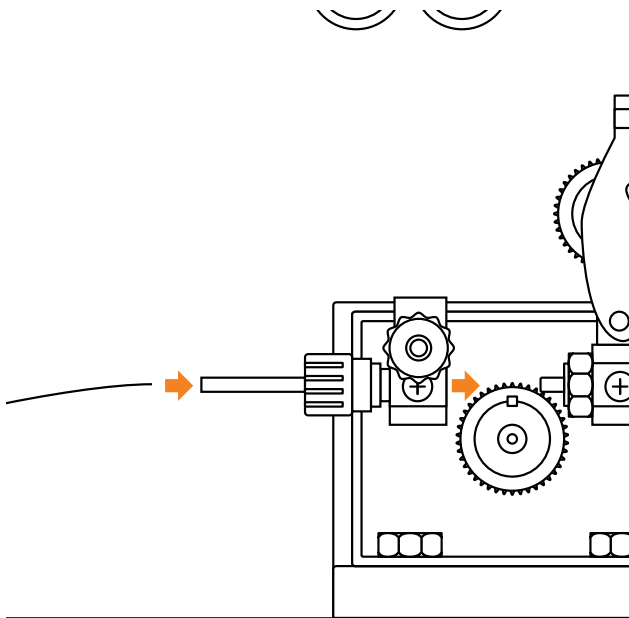

12 Lift roller tension knob to lock wire in place. Twist to tighten.

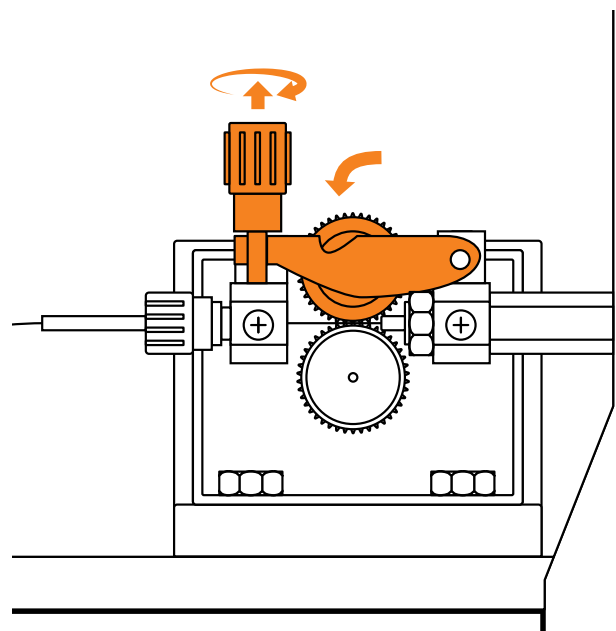

SETUP FOR MIG (GAS-SHIELDED)

- 13** Remove front end consumables from the MIG torch.

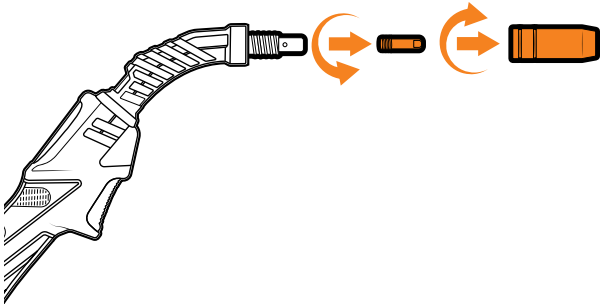

- 14** Hold the torch trigger to feed wire through to the torch. If the wire slips or stops you will need to adjust the roller tension knob.

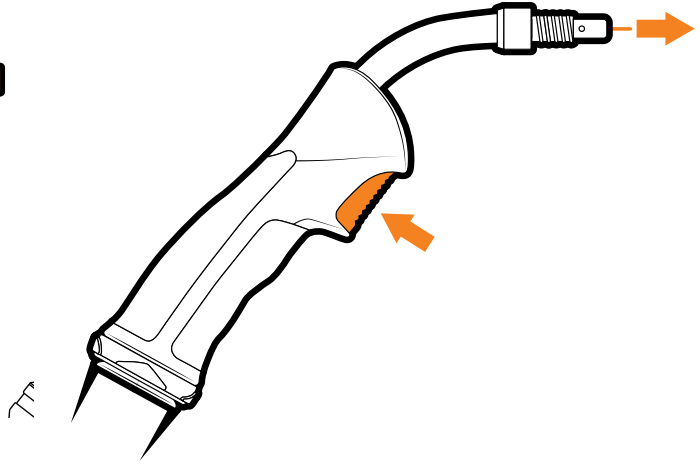

- 15** Replace front end consumables on the MIG torch.

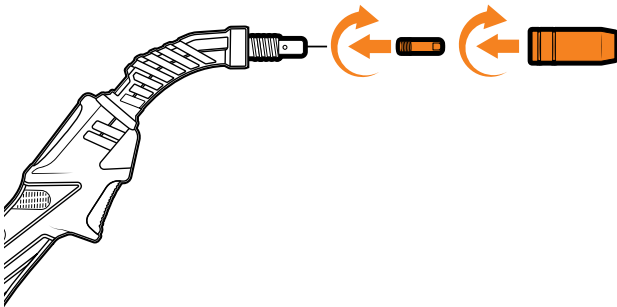

- 16** Place twin gauge argon regulator into your gas outlet.

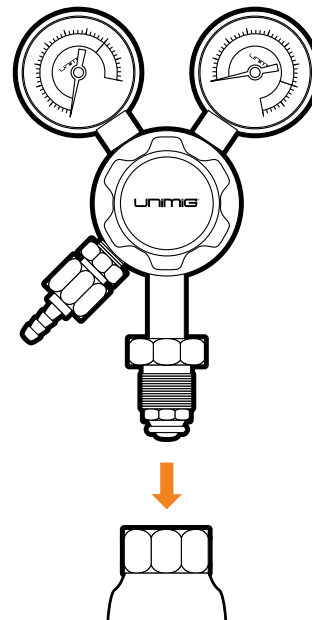

SETUP FOR MIG (GAS-SHIELDED)

- 17 Tighten securely with wrench.

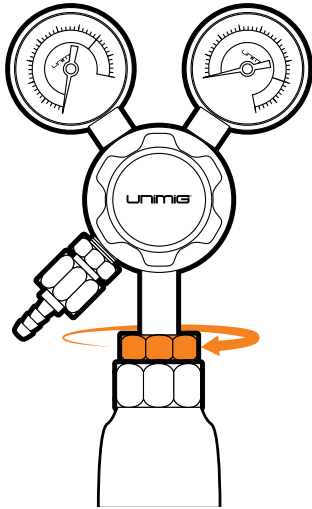

- 18 Connect gas hose to the regulator outlet, and crimp in place.

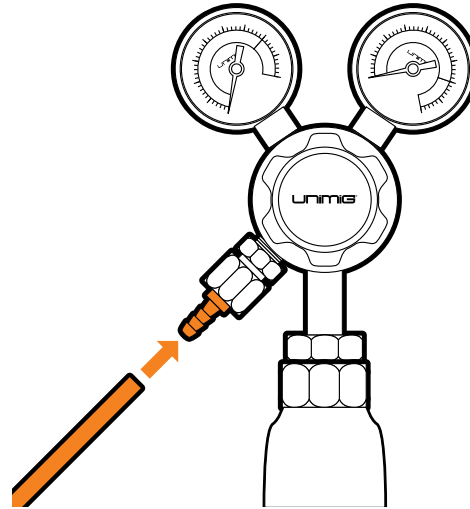

- 19 Adjust gas flow to 8-12L/min.

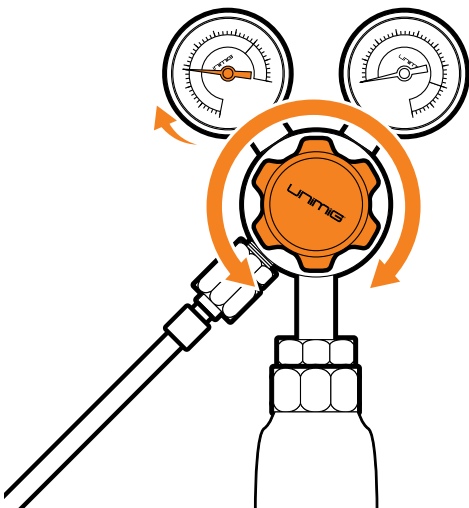

- 20 Connect gas hose to the gas inlet on the rear of the machine.

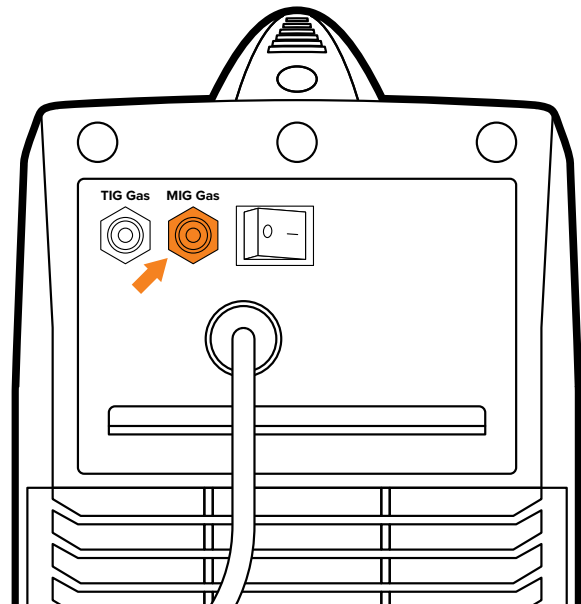

SETUP FOR MIG (GAS-SHIELDED)

21 Connect earth clamp to your workpiece.

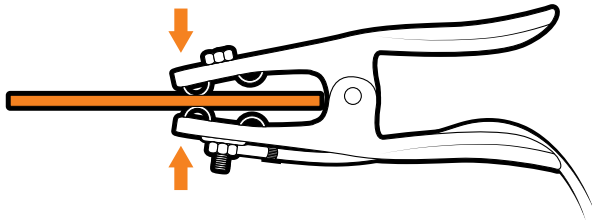

22 Set weld parameters on the digital screen. See "Digital Screen - MIG SMART-SET" on page 16.

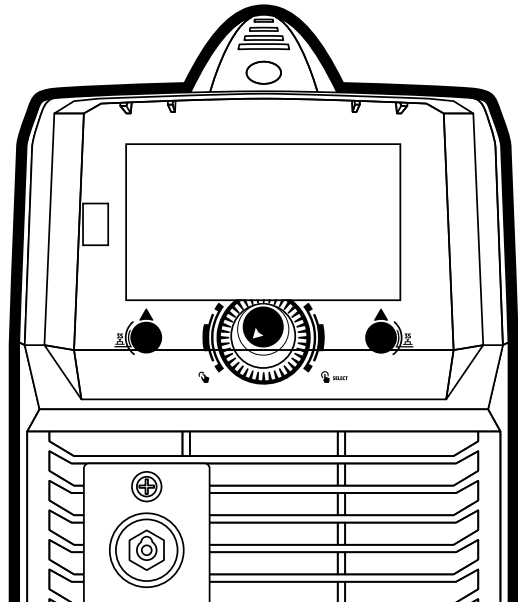

23 Line up the torch with your workpiece, then simply pull the trigger to initiate the weld. For gas-shielded MIG, the push method is recommended for optimum weld quality. Release trigger to end the weld.

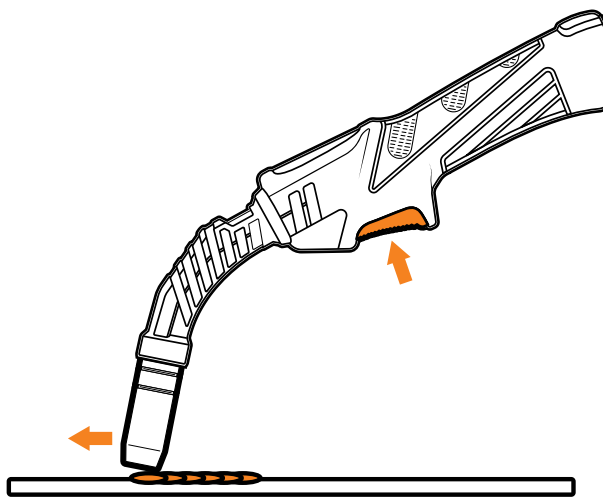

24 **For 1kg spool:** After removing spool holder nut, unscrew the 1kg spool bolt located inside the spool holder housing.

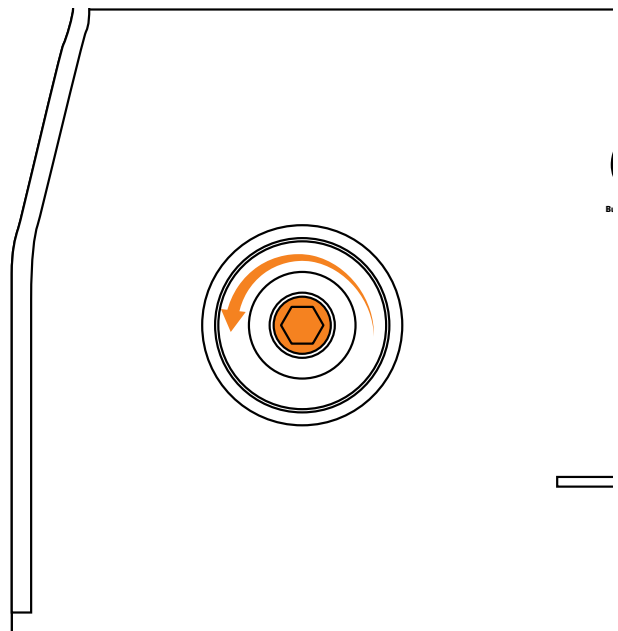

SETUP FOR MIG (GAS-SHIELDED)

25 For 1kg spool: Remove spool holder housing and spring. Place 1kg spool housing inside the square hole where the spool housing is removed from. The 1kg housing is found on the inside of the main spool holder housing.

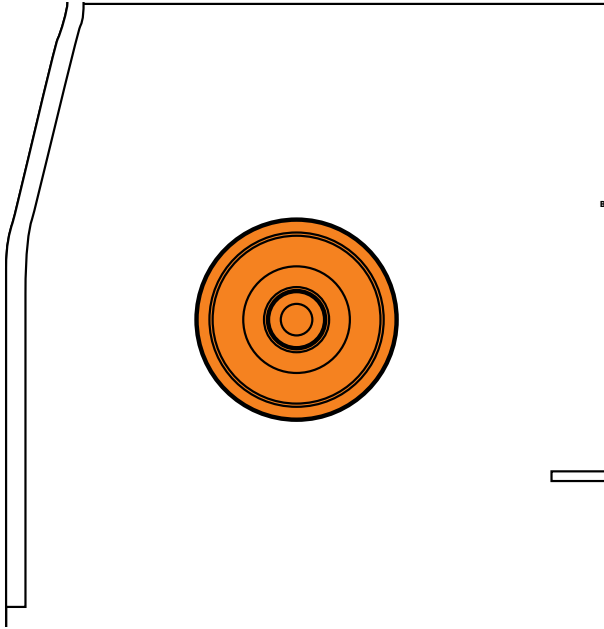

26 For 1kg spool: Place 1kg spool over 1kg spool housing, then tighten and secure with 1kg spool bolt and nut.

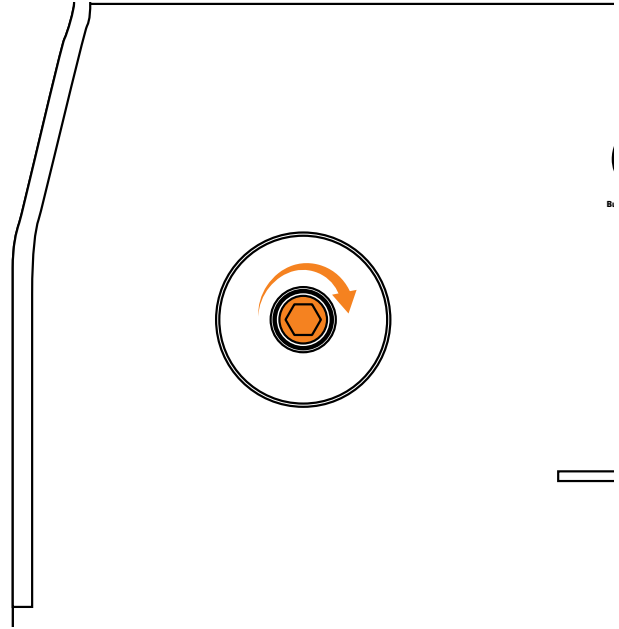

MIG (Metal Inert Gas) Welding

MIG (Metal Inert Gas) welding, also known as GMAW (Gas Metal Arc Welding) or MAG (Metal Active Gas Welding), is a semi-automatic arc welding process in which a consumable wire electrode and a shielding gas are fed through a welding gun. A constant voltage, direct current power source is most commonly used with MIG welding.

There are four primary methods of metal transfer in MIG welding. Short circuit (also known as dip transfer), globular transfer, spray transfer and pulse spray, each of which has distinct properties and corresponding advantages and limitations. To perform MIG welding, the necessary equipment is a welding gun, a wire feed unit, a welding power supply, an electrode wire, and a shielding gas supply.

Short Circuit Transfer

Short circuit transfer is the most commonly used method whereby the wire electrode is fed continuously down the welding torch through to and exiting the contact tip. The wire touches the workpiece and causes a short circuit the wire heats up and begins to form a molten bead, the bead separates from the end of the wire and forms a droplet that is transferred into the weld pool. This process is repeated about 100 times per second, making the arc appear constant to the human eye.

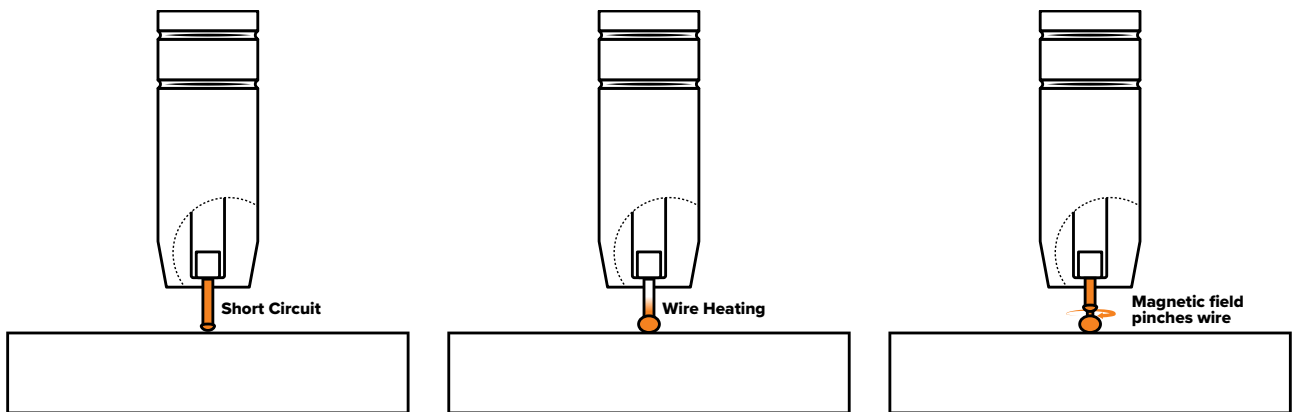

The wire approaches the workpiece and touches the work, creating a short circuit between the wire and the base metal, because there is no space between the wire and the base metal there is no arc and current flows through the wire.

The wire cannot support all the current flow, resistance builds up and the wire becomes hot and weak and begins to melt.

The current flow creates a magnetic field that begins to pinch the melting wire forming it into droplet.

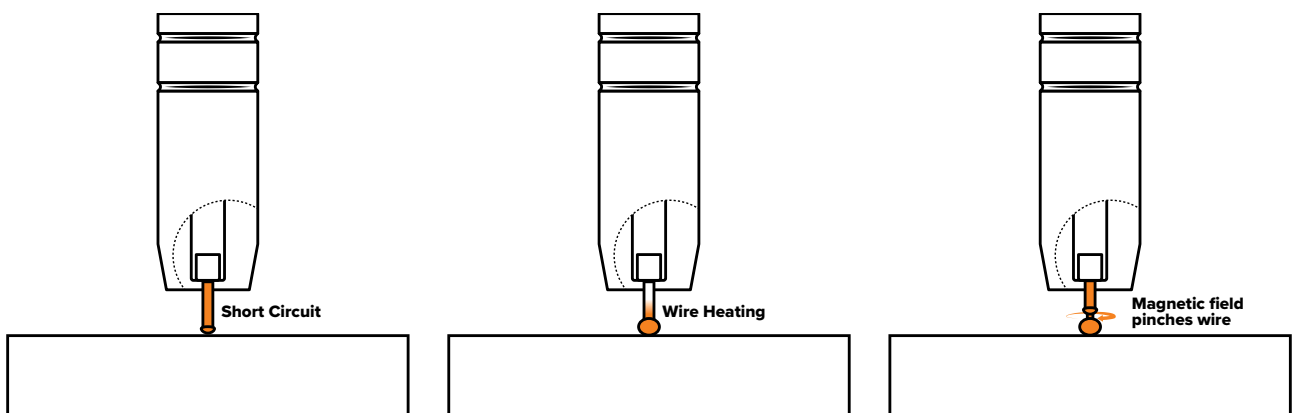

The pinch causes the forming droplet to separate and fall towards the forming weld pool.

An arc is created at the separation of the droplet and the heat and force of the arc flattens out the droplet into the weld pool. The heat of the arc melts the end of the wire slightly as it feeds towards the base metal.

The wire feed speed overcomes the heat of the arc and the wire again approaches the work to short circuit and repeat the cycle.

Basic MIG Welding

Good weld quality and weld profile depend on gun angle, the direction of travel, electrode extension (stick out), travel speed, the thickness of base metal, wire feed speed (amperage) and arc voltage. To follow are some basic guides to assist with your setup.

Gun Position - Travel Direction & Work Angle

Gun position or technique usually refers to how the wire is directed at the base metal, the angle and travel direction chosen. Travel speed and work angle will determine the characteristic of the weld bead profile and degree of weld penetration.

Push Technique

The wire is located at the leading edge of the weld pool and pushed towards the un-melted work surface. This technique offers a better view of the weld joint and direction of the wire into the weld joint. Push technique directs the heat away from the weld puddle, allowing faster travel speeds providing a flatter weld profile with light penetration - useful for welding thin materials. The welds are wider and flatter, allowing for minimal clean up / grinding time.

Perpendicular Technique

The wire is fed directly into the weld. This technique is used primarily for automated situations or when conditions make it necessary. The weld profile is generally higher, and deeper penetration is achieved.

Pull/Drag Technique

The gun and wire are dragged away from the weld bead. The arc and heat are concentrated on the weld pool. The base metal receives more heat, deeper melting, more penetration and the weld profile is higher with more buildup.

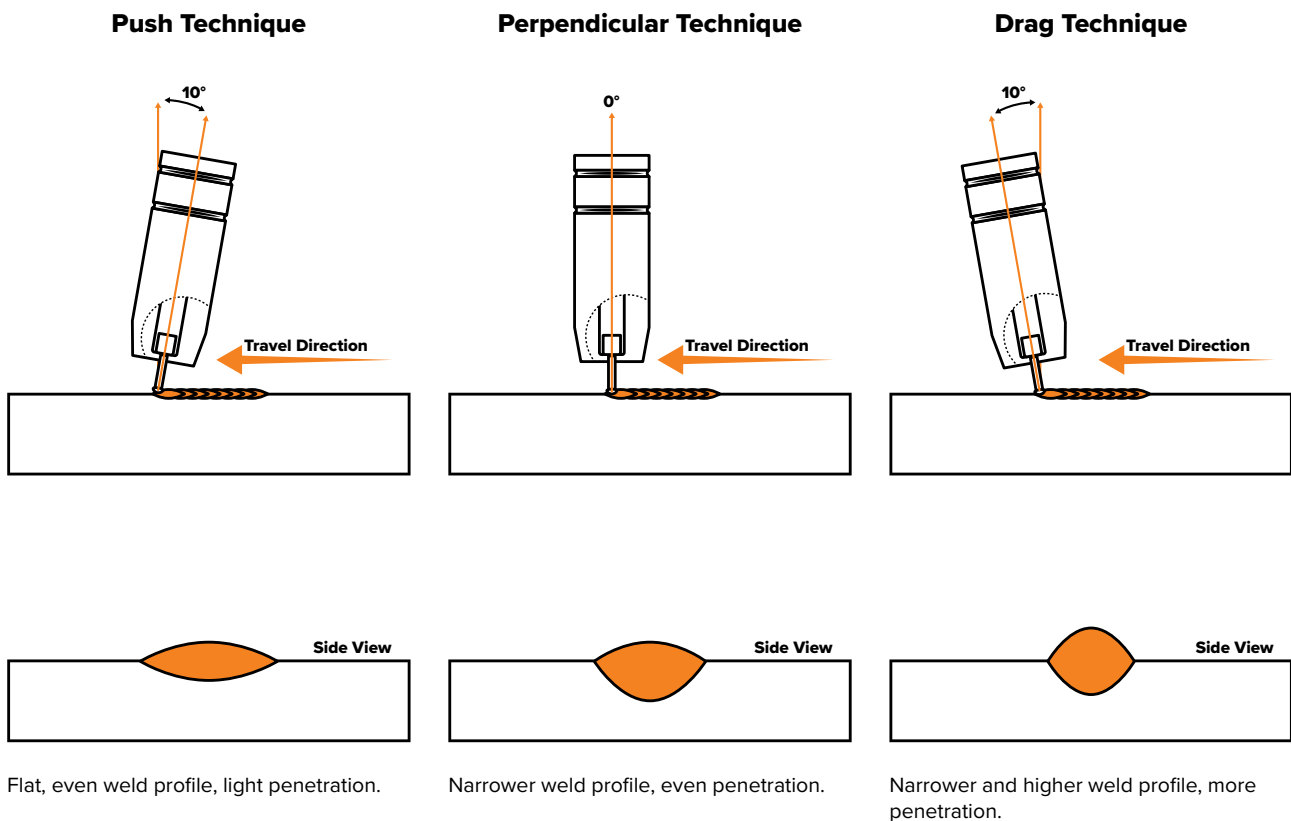

Travel Angle

The travel angle is the right to left, relative to the direction of welding. A travel angle of 5° - 15° is ideal and produces the right level of control over the weld pool. A travel angle higher than 20° will give an unstable arc condition with poor weld metal transfer, less penetration, high levels of spatter, weak gas shielding and a poor quality finished weld.

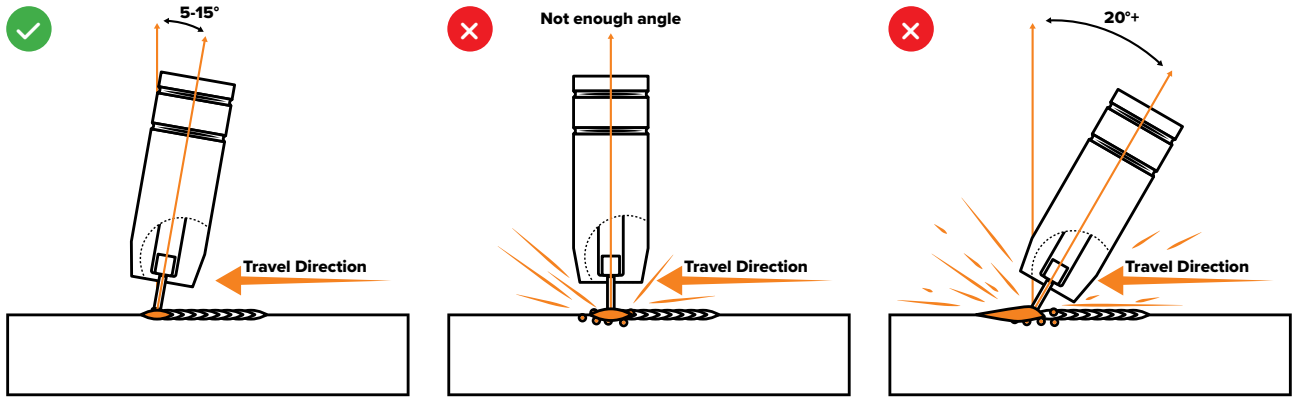

Good level of control over the weld pool, even flat weld.

Less control over the weld pool, more spatter.

Poor control, unstable arc, less penetration, lots of spatter.

Work Angle

The work angle is the up and down angle of the gun relative to the workpiece.

The correct work angle provides good bead shape, prevents undercut, uneven penetration, weak gas shielding and a poor quality finished weld.

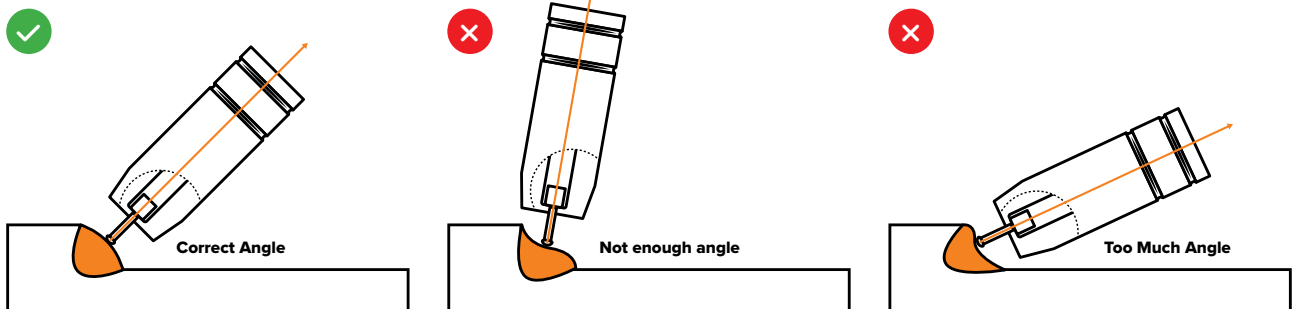

Good level of control over the weld pool, even flat weld.

Less control over the weld pool, more spatter.

Poor control, unstable arc, less penetration, lots of spatter.

Stick Out

Stick out is the length of the unmelted wire protruding from the end of the contact tip.

A constant, even stick out of 5-10mm will produce a stable arc and an even current flow providing good penetration and even fusion. Too short a stick out will cause an unstable weld pool, produce spatter and overheat the contact tip. Too long stick out will cause an unstable arc, lack of penetration, lack of fusion, and increase spatter.

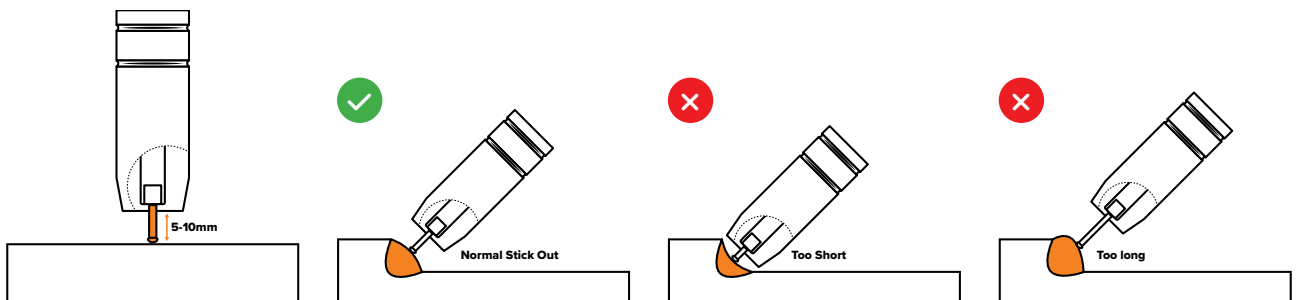

Even arc, good penetration even fusion, good finish.

Unstable arc, spatter, over heat contact tip.

Unstable arc, spatter, poor penetration and fusion.

Travel Speed

Travel speed is the rate that the gun is moved along the weld joint and is usually measured in mm per minute. Travel speeds can vary depending on conditions and the welder's skill and is limited to the welder's ability to control the weld pool. The push technique allows faster travel speeds than the drag technique.

The gas flow must also correspond with the travel speed, increasing with faster travel speed and decreasing at a slower speed. Travel speed needs to match the amperage and will decrease as the material thickness and amperage increase.

Travel Speed Too Fast

Too fast a travel speed produces too little heat per mm of travel resulting in less penetration and reduced weld fusion. The weld bead solidifies very quickly, trapping gases inside the weld metal and causing porosity. Undercutting of the base metal can also occur, and an unfilled groove in the base metal is created when the travel speed is too fast to allow molten metal to flow into the weld crater created by the arc heat.

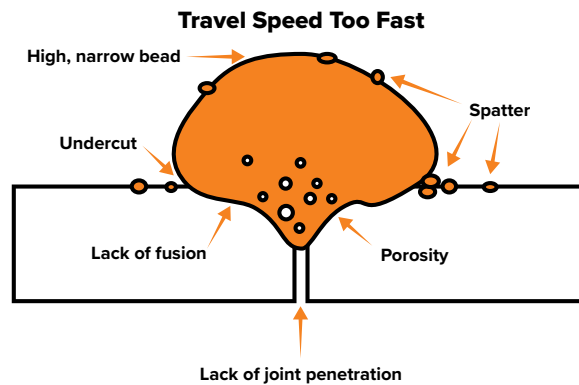

Travel Speed Too Slow

Too slow a travel speed produces a large weld with a lack of penetration and fusion. The energy from the arc dwells on top of the weld pool rather than penetrating the base metal. This produces a wider weld bead with more deposited weld metal per mm than is required, resulting in a weld deposit of poor quality.

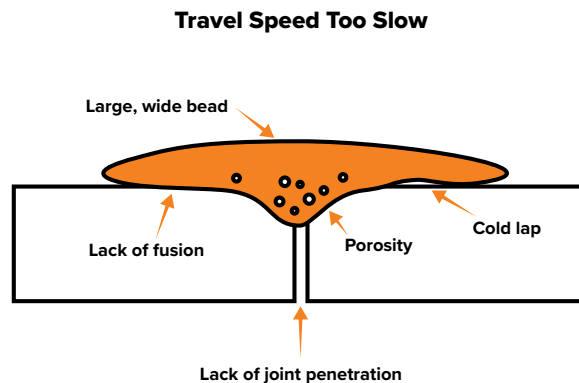

Correct Travel Speed

The correct travel speed keeps the arc at the leading edge of the weld pool, allowing the base metal to melt sufficiently to create good penetration, fusion and wetting out of the weld pool producing a weld deposit of good quality.

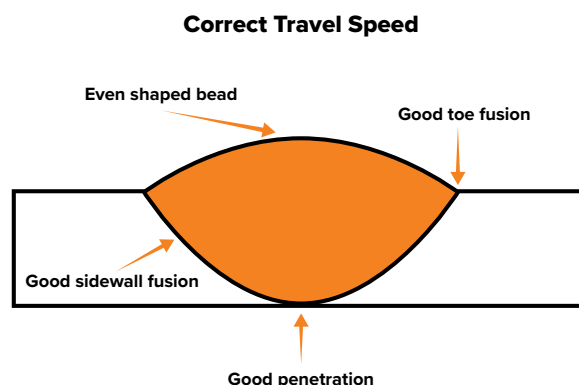

Wire Types and Sizes

Use the correct wire type for the base metal being welded. Use stainless steel wire for stainless steel, aluminium wires for aluminium and steel wires for steel.

Using poor quality milled wire can result in poor performance and appearance. To ensure optimal performance when welding, use standards approved wire such as UNIMIG HYPERMIG wire.

Use a smaller diameter wire for thin base metals. For thicker materials use a larger wire diameter and larger machine. Check the recommended welding capability of your machine.

As a guide, refer to the "Welding Wire Thickness Chart" below.

Material Type	Wire Type	Wire Size	Drive Roller	Polarity	Shielding Gas	Gas Flow Rate	Material Thickness	2mm	3mm	4mm	6mm	8mm	10mm
							2mm	3mm	4mm	6mm	8mm	10mm	
Steel	ER70S-6	0.8mm	V Groove	DCEP+	ArCO2 5/2	8-12L/min	Voltage (V)	18.5	19.1	20	22.1	23.8	25.5
							Wire Speed (m/min)	7.8	8.5	9	12.5	13.4	15.6
	ER70S-6	0.9mm	V Groove	DCEP+	ArCO2 5/2	8-12L/min	Voltage (V)	18	18.6	21.9	23.1	25.8	
							Wire Speed (m/min)	6.5	7	10.1	11.9	13.3	
	E71T-11	0.8mm	F Groove (Knurled)	DCEN-	/	/	Voltage (V)	13	14.8	15.6	17.5	19.2	21.3
							Wire Speed (m/min)	4.7	5.7	6	6.6	7.7	10.6
	E71T-11	0.9mm	F Groove (Knurled)	DCEN-	/	/	Voltage (V)	13.2	14.9	15.7	19.5	21	22
							Wire Speed (m/min)	5	6.2	6.5	8	10.6	11.3
Stainless Steel	316LSi	0.8mm	V Groove	DCEP+	ArCO2	8-12L/min	Voltage (V)	17.7	18.6	19.7	24.7	25.5	/
							Wire Speed (m/min)	7.9	8.6	10.6	15	15.5	/
	316LSi	0.9mm	V Groove	DCEP+	ArCO2	8-12L/min	Voltage (V)	18	19.4	21	22.3	23.7	24.6
							Wire Speed (m/min)	8.3	9.6	10.2	12.2	13.3	14.4
Aluminium	5356	1.0mm	U Groove	DCEP+	Ar	8-12L/min	Voltage (V)	13.3	16.3	17	20.7	/	/
							Wire Speed (m/min)	7.5	11	12.9	15.5	/	/

Gas Selection

The purpose of the gas in the MIG process is to shield the wire, the arc and the molten weld metal from the atmosphere. Most metals when heated to a molten state will react with the air in the atmosphere, without the protection of the shielding gas the weld produced would contain defects like porosity, lack of fusion and slag inclusions. Additionally, some of the gas becomes ionised (electrically charged) and helps the current flow smoothly.

- The correct gas flow is critical in protecting the welding zone from the atmosphere.
- Too low a flow will give inadequate coverage and result in weld defects and unstable arc conditions.
- Too high a flow can cause air to be drawn into the gas column and contaminate the weld zone.

Use the correct shielding gas. CO₂ is suitable for steel and offers good penetration characteristics; the weld profile is narrower and slightly more raised than the weld profile obtained from Argon CO₂ mixed gas. Argon CO₂ mix gas offers better weldability for thin metals and has a wider range of setting tolerance on the machine. Argon-CO₂ 5/2 is a good all-round mix suitable for most applications.

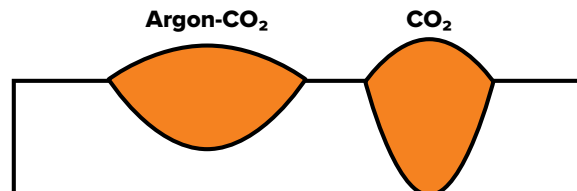

SETUP FOR SPOOL GUN

- 1 Connect the polarity connector to the **positive (+)** connection, unscrew the bolt and move the connector then screw and tighten in place.

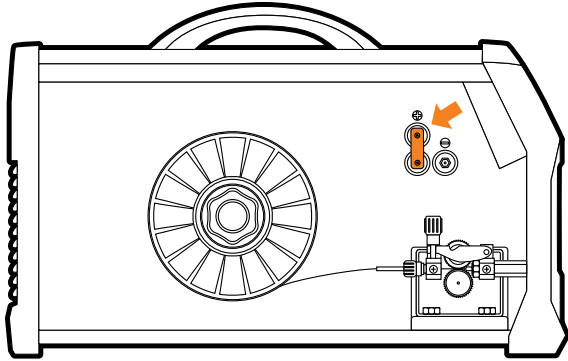

- 2 Connect the earth clamp to the **negative (-)** dinse connection, twist to lock in place.

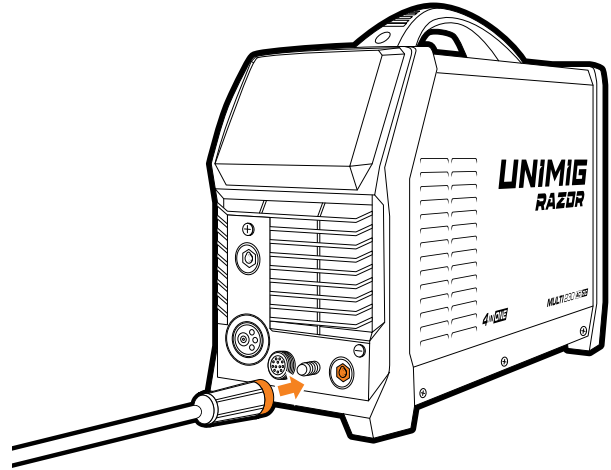

- 3 Connect the Spool Gun to the Euro connection, and twist end to secure in place. **Insert the spool gun control cable into the 12-pin socket at the rear of the machine.**

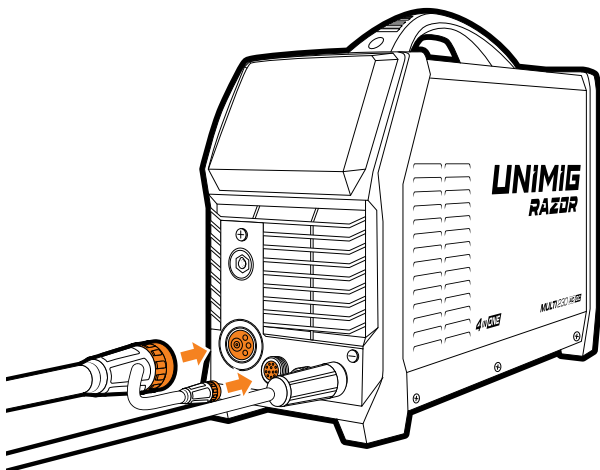

- 4 Connect the plug into a 15 AMP socket, then switch the machine ON.

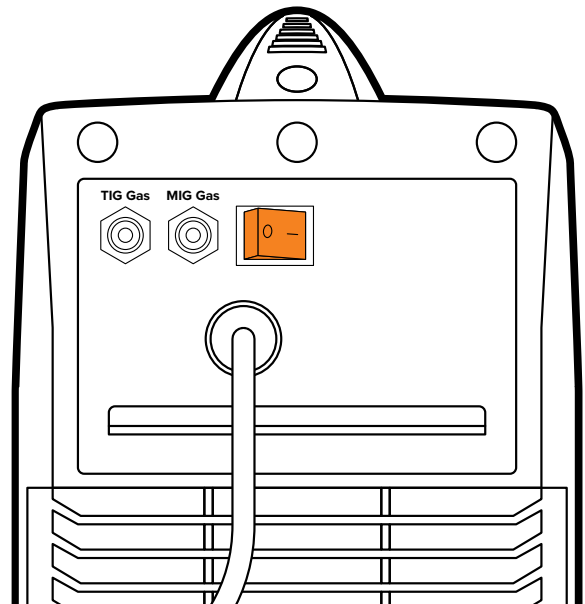

SETUP FOR SPOOL GUN

5 Unscrew spool holder.

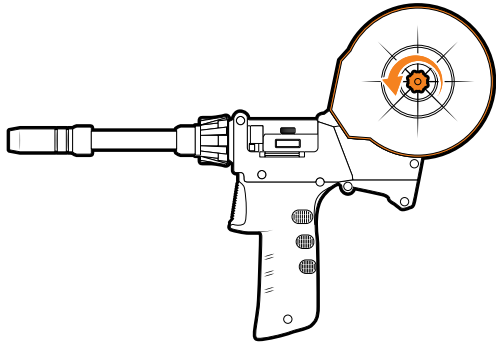

6 Push back the spool guides, and place wire spool onto the spool nut.

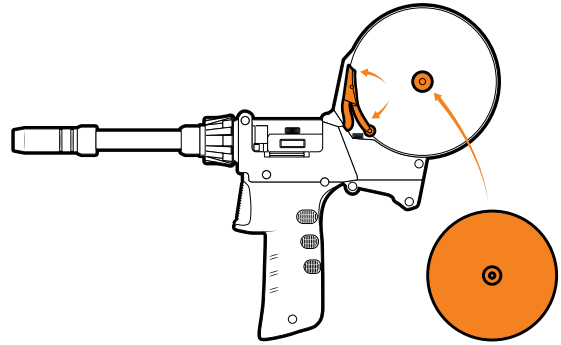

7 Feed wire through the inlet guide tube.

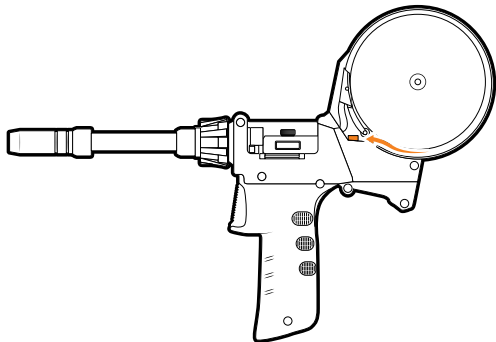

8 Open cover and loosen roller lock.

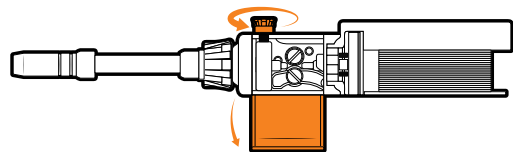

SETUP FOR SPOOL GUN

- 9 Open the wire drive.

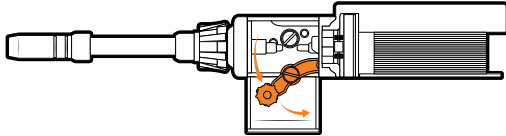

- 10 Unscrew roller nut.

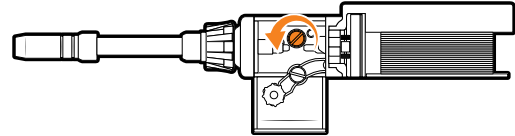

- 11 Ensure you have the correct roller for the wire size you are using. If not, replace with correct size.

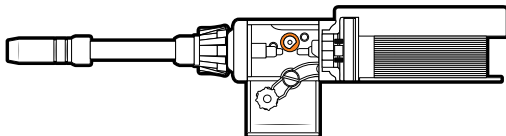

- 12 Replace roller nut and tighten.

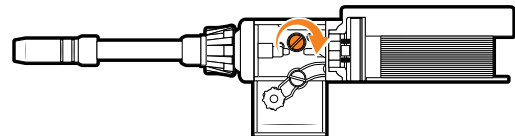

SETUP FOR SPOOL GUN

- 13 Feed wire through roller, and through the outlet guide tube.

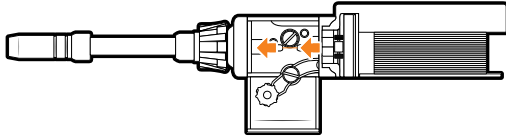

- 14 Close wire drive and tighten roller tension knob.

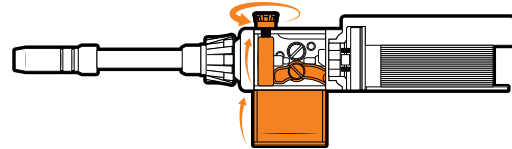

- 15 Remove front end consumables.

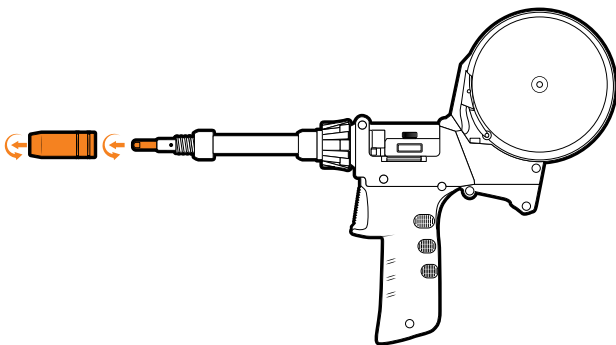

- 16 Push trigger to feed wire out the torch nozzle.

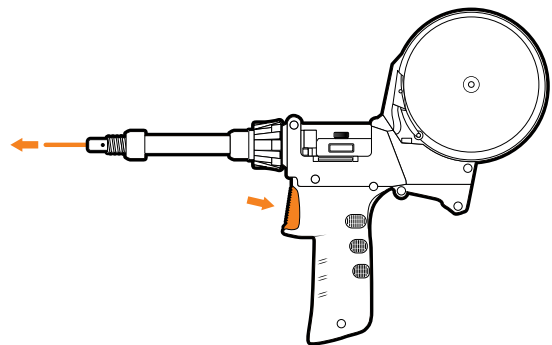

SETUP FOR SPOOL GUN

17 Replace front end consumables.

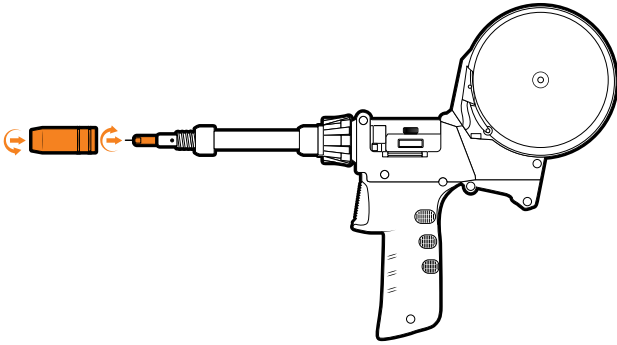

18 Replace spool cover and tighten.

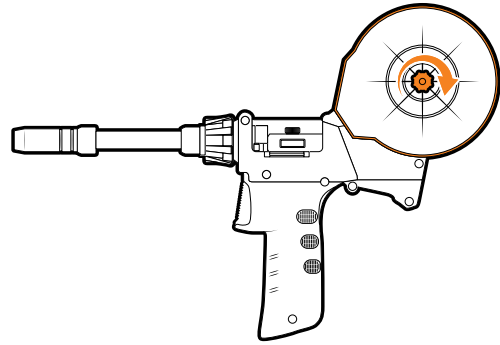

19 Place twin gauge argon regulator into your gas outlet.

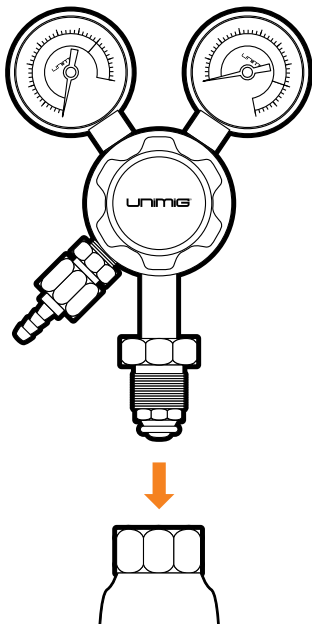

20 Tighten securely with wrench.

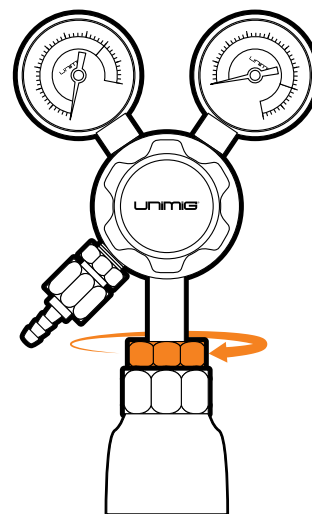

SETUP FOR SPOOL GUN

- 21** Connect gas hose to the regulator outlet, and crimp in place.

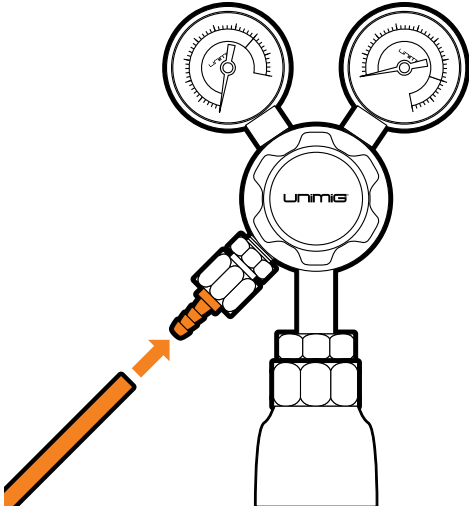

- 22** Adjust gas flow to 8-12L/min.

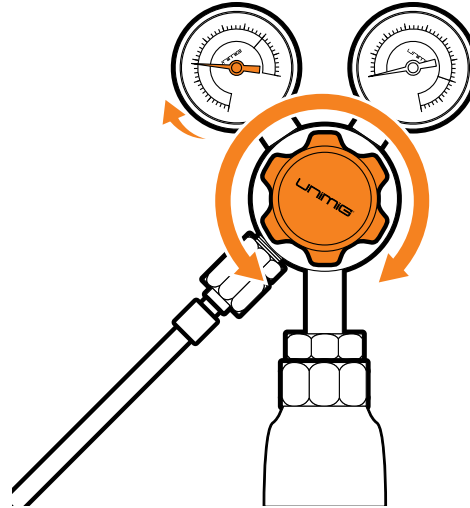

- 23** Connect gas hose to the gas inlet on the rear of the machine.

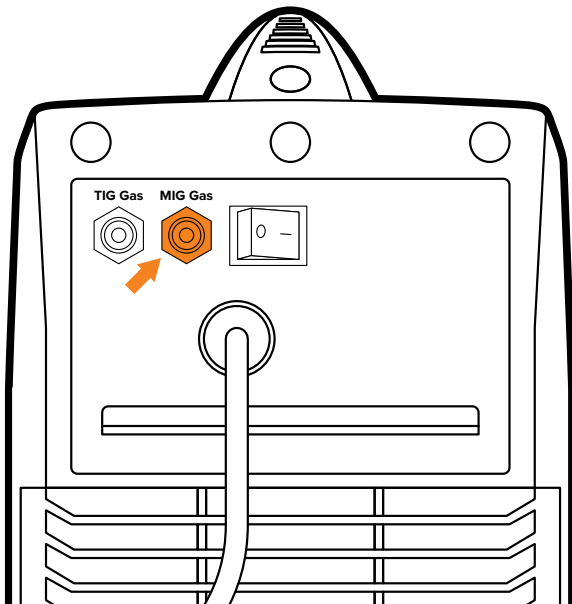

- 24** Connect earth clamp to your workpiece.

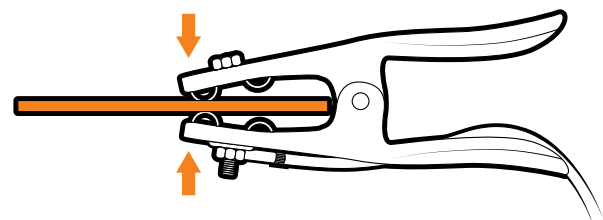

SETUP FOR SPOOL GUN

- 25** Set weld parameters on the digital screen. See "Digital Screen - MIG SMART-SET" on page 16.

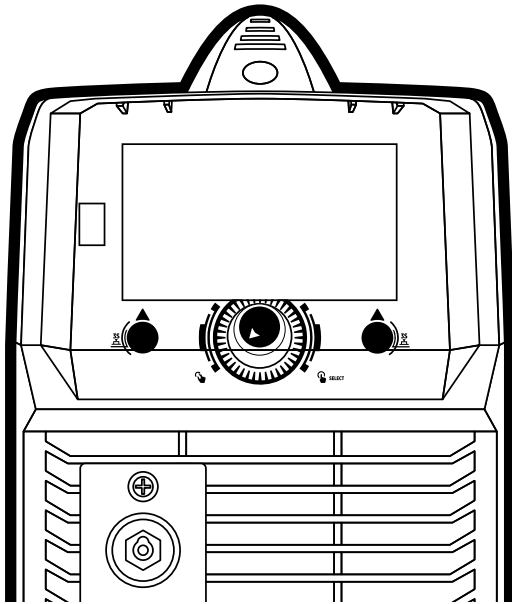

- 26** Line up the torch with your workpiece, then simply pull the trigger to initiate the weld. Release trigger to end the weld.

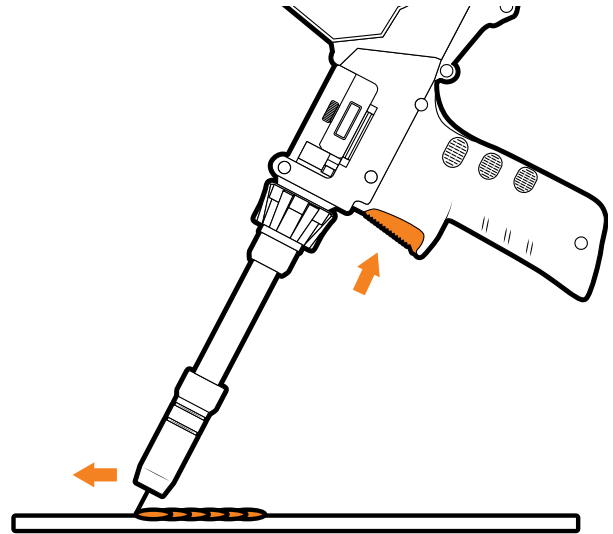

CHANGING THE MIG TORCH LINER

1 Remove MIG torch front end parts.

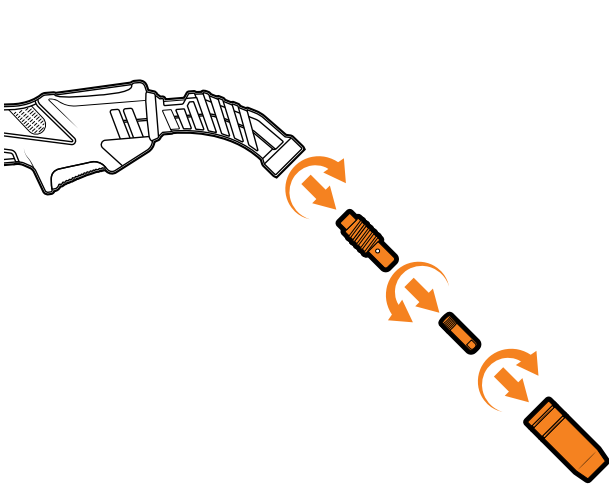

2 Remove the liner retaining nut.

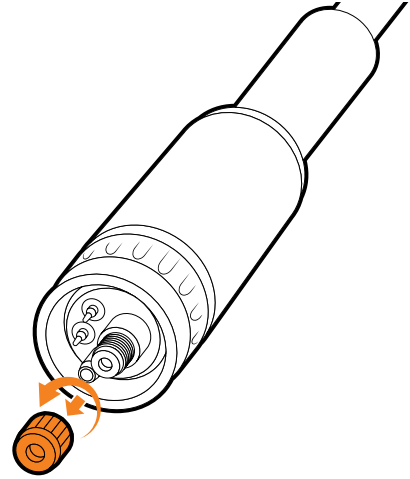

3 Carefully pull out and completely remove the existing liner. Ensure MIG torch is completely unraveled until setup is complete.

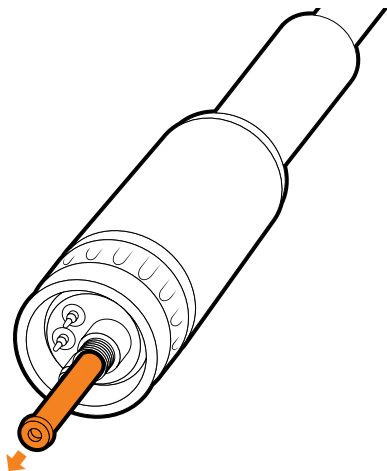

4 Carefully feed in the new liner down the torch lead all the way to exit the torch neck.

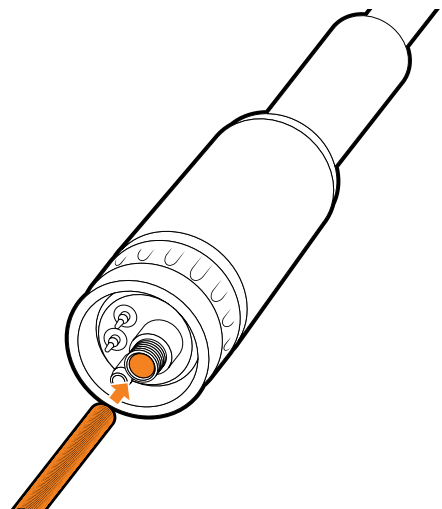

CHANGING THE MIG TORCH LINER

- 5 Fit the liner retaining nut and screw only 1/2 way down.

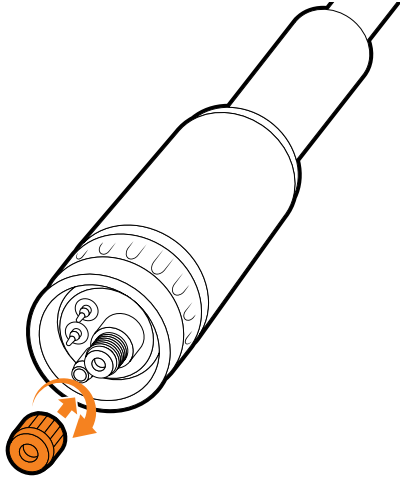

- 6 Snip the excess liner off, about the length of the where tip holder sits past the end of the torch neck.

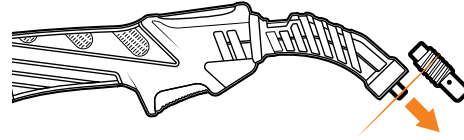

- 7 Replace the front end parts

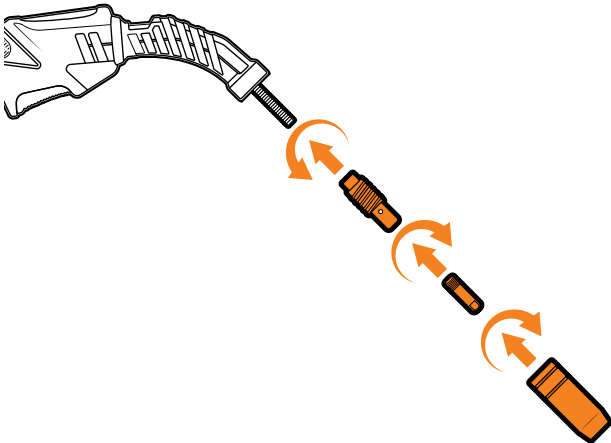

- 8 Fully screw down the liner retaining nut and nip it up tight. This compresses the liner inside the torch cable assembly preventing it moving during use and ensures good wire feed.

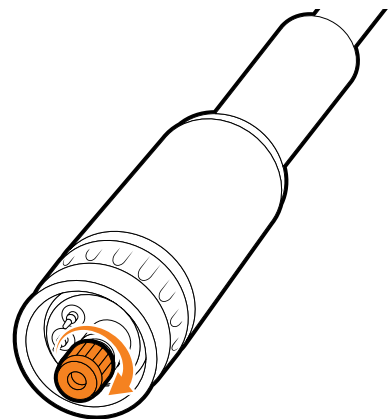

CHANGING THE MIG TORCH LINER (ALUMINIUM)

1 Remove MIG torch front end parts.

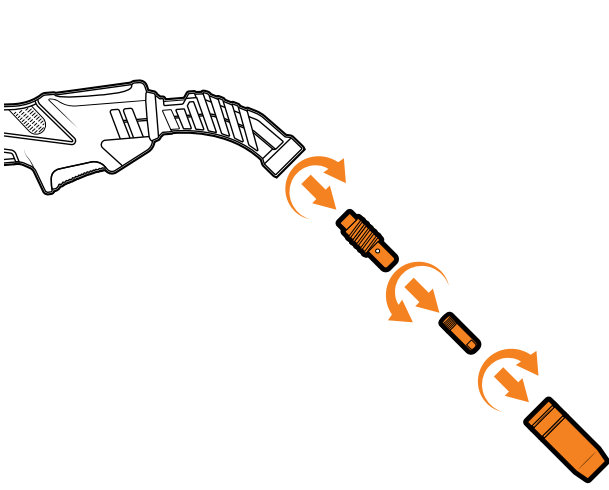

2 Remove the liner retaining nut.

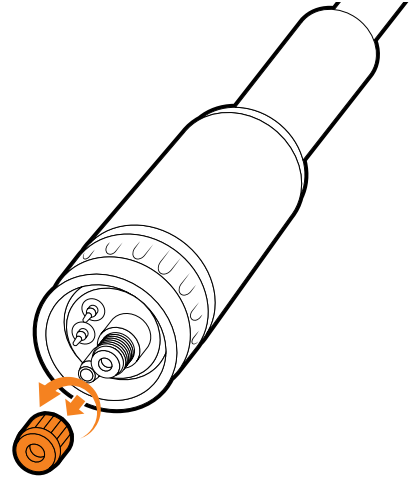

3 Carefully pull out and completely remove the existing liner. Ensure MIG torch is completely unravelled until setup is complete.

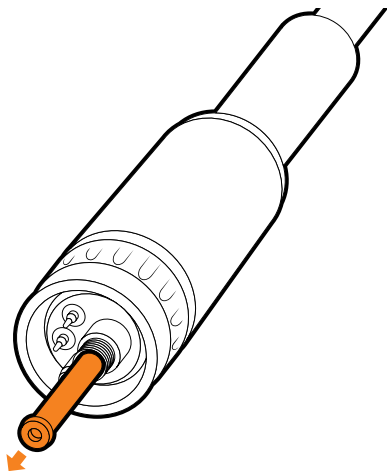

4 Fit the neck spring to the front end of the aluminium liner.

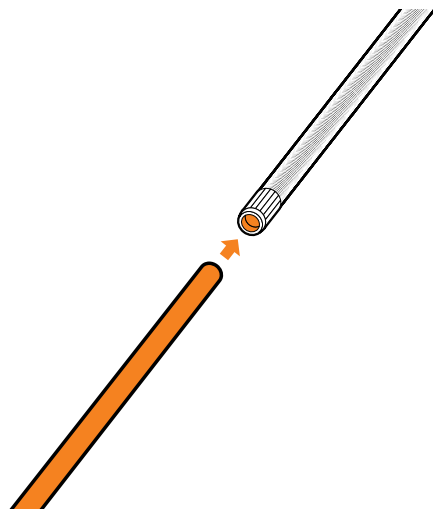

CHANGING THE MIG TORCH LINER (ALUMINIUM)

- 5 Feed liner and neck spring through the torch, then fit liner collet, liner O-ring and liner retaining nut.

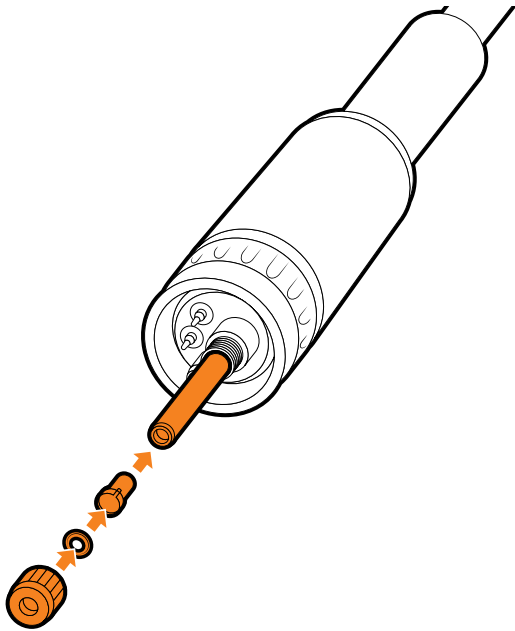

- 6 Push the liner firmly into the torch lead and tighten the liner retaining nut.



- 7 Loosen the inlet guide tube retaining screw.

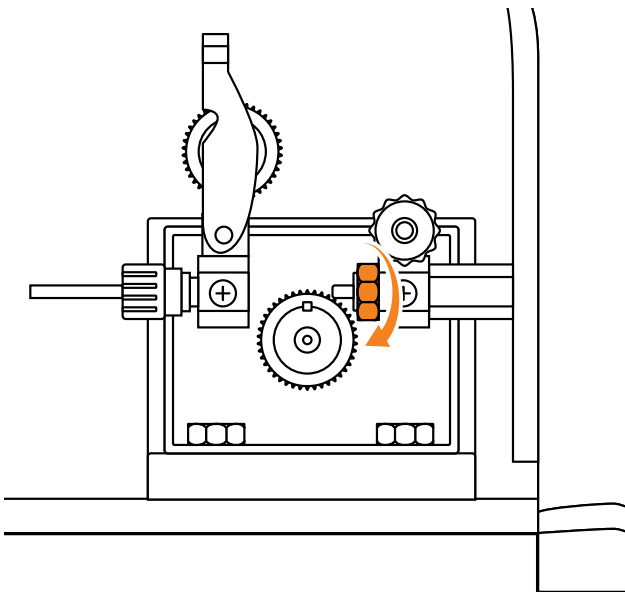

- 8 Remove the inlet guide tube using long nose pliers.

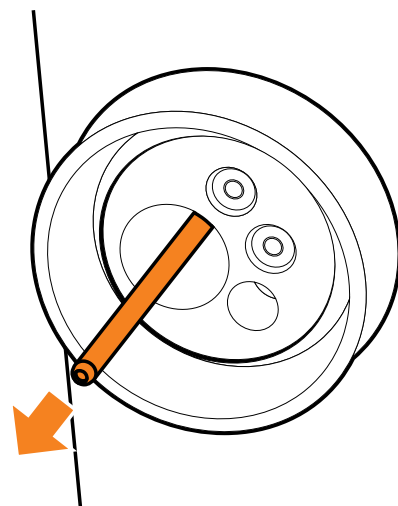

CHANGING THE MIG TORCH LINER (ALUMINIUM)

- 9 Install a U groove drive roller of the correct size for the diameter wire being used.

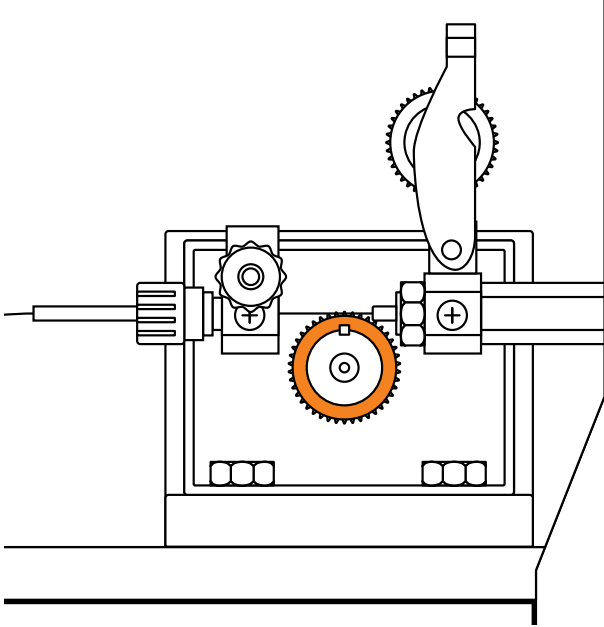

- 10 Feed liner through Euro connection, and connect and tighten the torch.

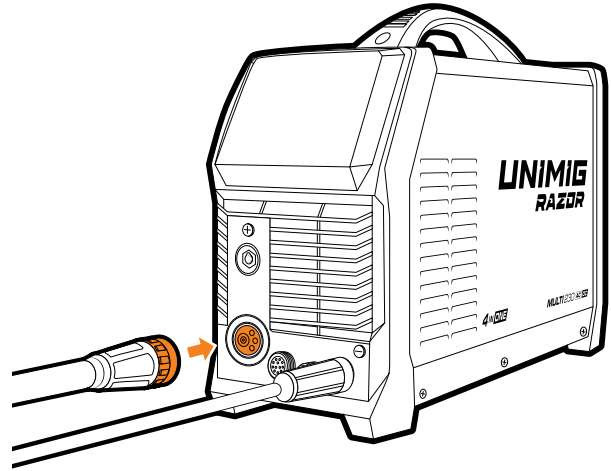

- 11 Take the extended aluminium liner all the way up and over the drive roller.

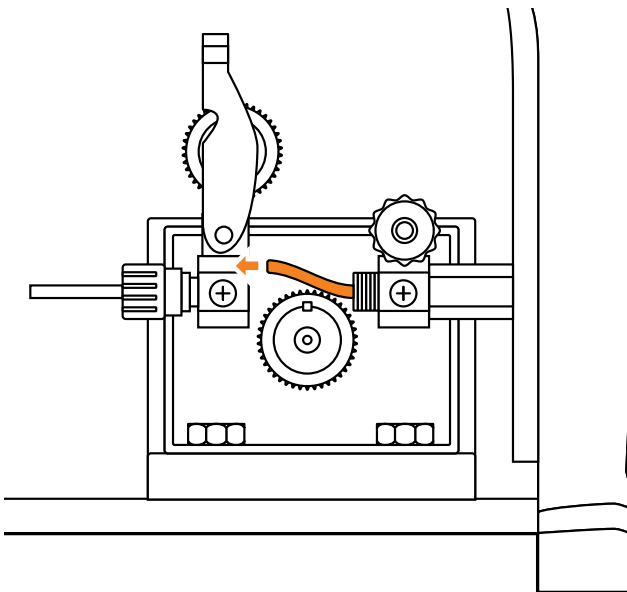

- 12 Cut the extended aluminium liner with a sharp knife just in front of the drive roller.

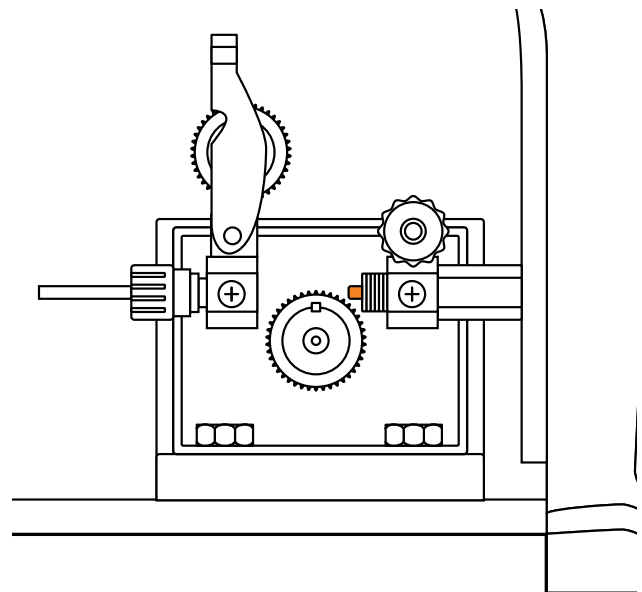

CHANGING THE MIG TORCH LINER (ALUMINIUM)

- 13 Replace the front end parts.

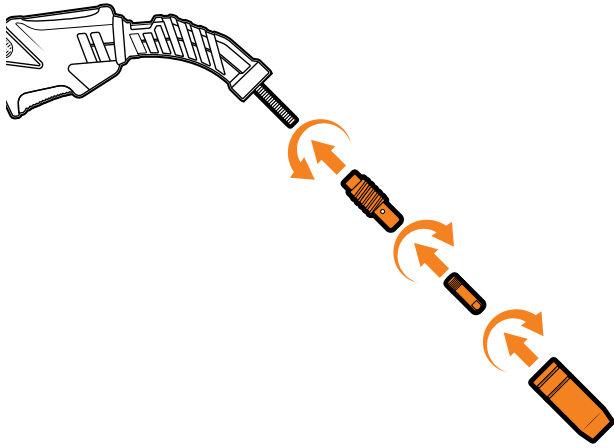

SETUP FOR STICK (MMA) WELDING

- 1 For DC+ electrodes, connect earth clamp to the **negative (-)** dinse connection, and electrode holder to the **positive (+)** dinse connection.

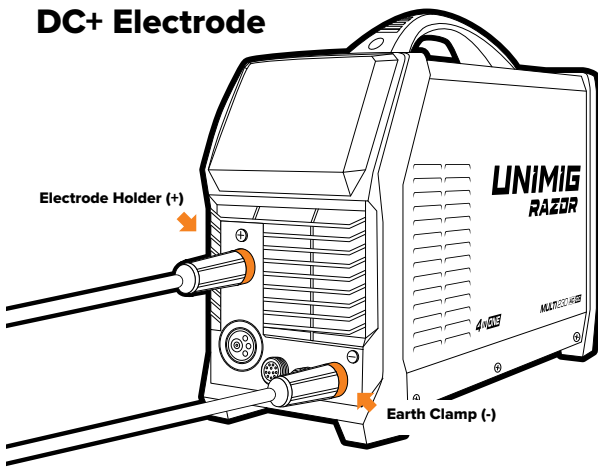

- 2 For DC- electrodes, connect earth clamp to the **positive (+)** dinse connection, and electrode holder to the **negative (-)** dinse connection.

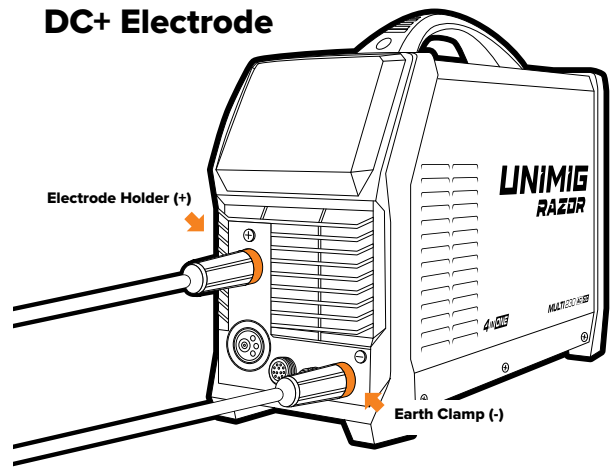

- 3 Connect the plug into a 15 AMP socket, then switch the machine ON.

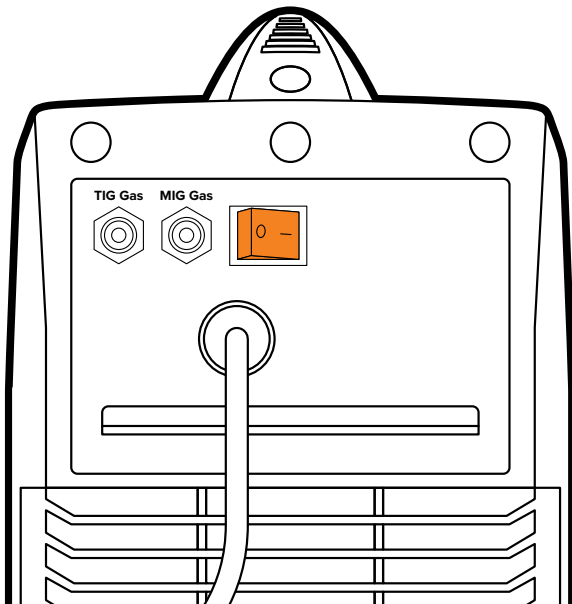

- 4 Set weld parameters on the digital screen. See "Digital Screen - MMA (STICK)" on page 14.

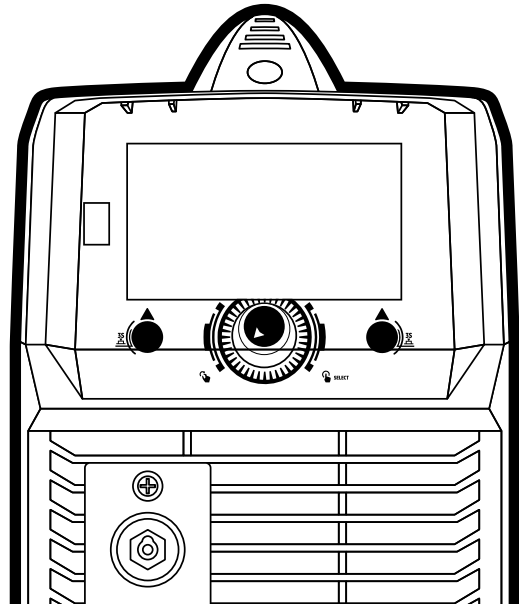

SETUP FOR STICK (MMA) WELDING

- 5 Twist electrode holder to loosen grip.

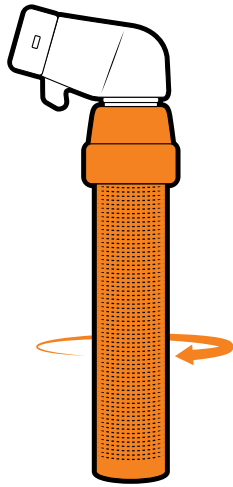

- 6 Place electrode into electrode holder.

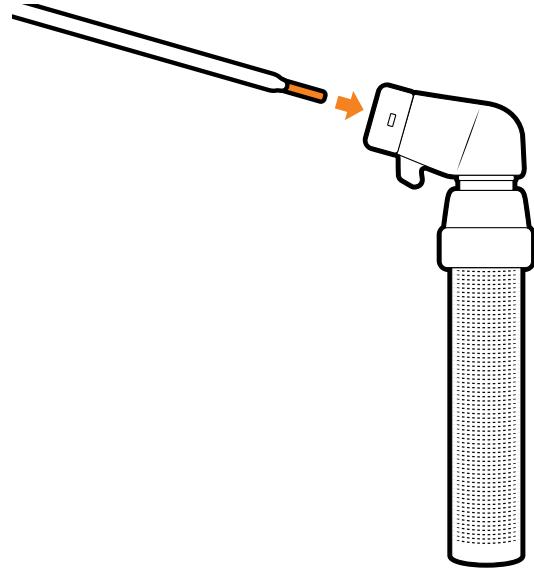

- 7 Twist electrode holder to tighten and securely grip electrode.

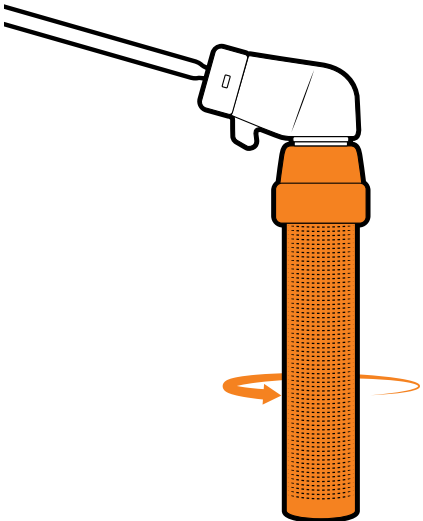

- 8 Connect earth clamp to your workpiece.

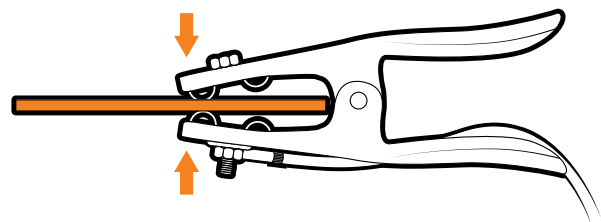

SETUP FOR STICK (MMA) WELDING

- 9** Strike electrode against workpiece to initiate arc.

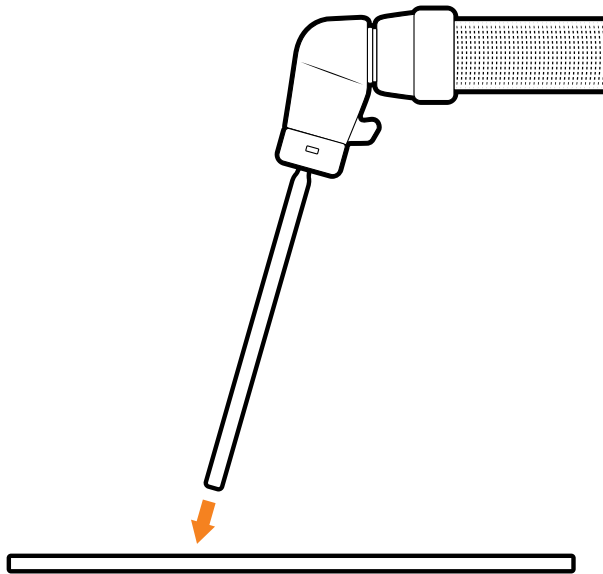

- 10** Drag along workpiece to weld. Pull the electrode away from the workpiece to finish weld.

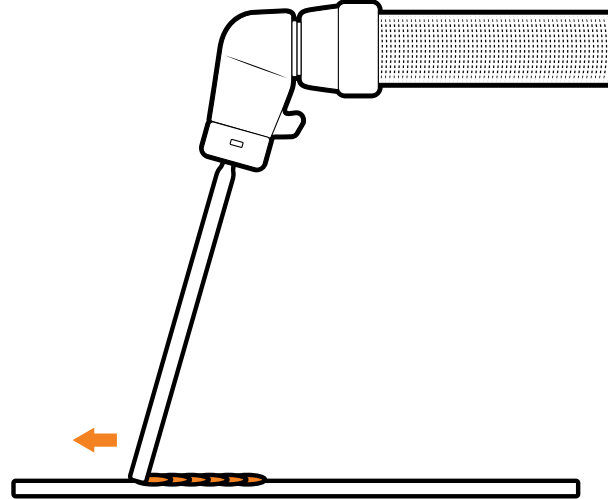

STICK (MMA / Manual Metal Arc) Welding

One of the most common types of arc welding is Manual Metal Arc welding, also known as MMA welding. An electric current is used to strike an arc between the base material and a consumable electrode rod or 'stick'. The electrode rod is made of a material that is compatible with the base material being welded. They are covered with a flux that gives off gaseous vapours that serve as a shielding gas and provide a layer of slag, both of which protect the weld area from atmospheric contamination. The electrode core itself acts as filler material. The residue from the flux that forms a slag covering over the weld metal must be chipped away after welding.

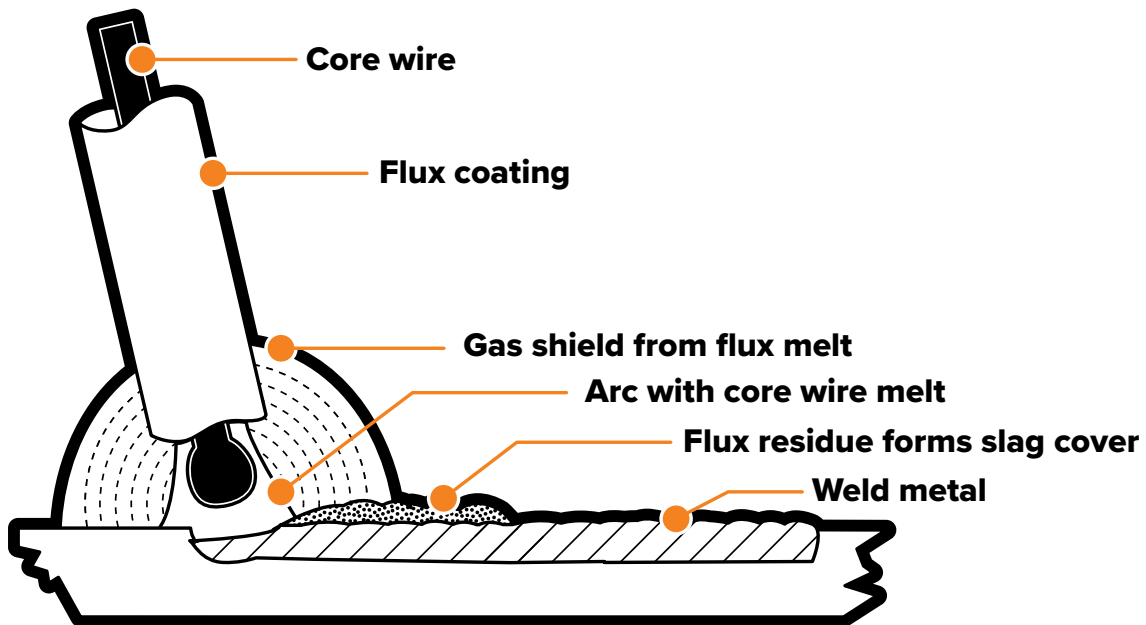

- The arc is initiated by momentarily touching the electrode to the base metal.
- The heat of the arc melts the surface of the base metal to form a molten pool at the end of the electrode.
- The melted electrode metal is transferred across the arc into the molten pool and becomes the deposited weld metal.
- The deposit is covered and protected by a slag which comes from the electrode coating.
- The arc and the immediate area are enveloped by an atmosphere of protective gas.

Manual Metal Arc (stick) electrodes have a solid metal wire core and a flux coating. These electrodes are identified by the wire diameter and by a series of letters and numbers. The letters and numbers identify the metal alloy and the intended use of the electrode.

The metal wire core works as a conductor of the current that maintains the arc. The core wire melts and is deposited into the welding pool.

The covering on a shielded metal arc welding electrode is called flux. The flux on the electrode performs many different functions.

These include:

- Producing a protective gas around the weld area
- Providing fluxing elements and de-oxidisers
- Creating a protective slag coating over the weld as it cools
- Establishing arc characteristics
- Adding alloying elements.

Covered electrodes serve many purposes in addition to adding filler metal to the molten pool. These additional functions are provided mainly by the covering on the electrode.

MMA (STICK) WELDING GUIDE

Electrode Selection

As a general rule, the selection of an electrode is straight forward, in that it is only a matter of selecting an electrode of similar composition to the parent metal. However, for some metals, there is a choice of several electrodes, each of which has particular properties to suit specific classes of work.

The size of the electrode generally depends on the thickness of the section being welded, and the thicker the section, the larger the electrode required. The table gives the maximum size of electrodes that may be used for various thicknesses of section based on using a general-purpose type 6013 electrode.

Average Thickness of Material	Maximum Recommended Electrode Diameter
3-6mm	2.6mm
6-12mm	3.2mm
12-20mm	4.0mm
20mm+	5.0mm

Correct current selection for a particular job is an important factor in arc welding. With the current set too low, it is difficult to strike and maintain a stable arc. The penetration is reduced and beads with a distinct rounded profile will be deposited. Too high a current is accompanied by overheating of the electrode, resulting in undercut, burning through of the base metal and producing excessive spatter. Normal current for a particular job may be considered as the maximum, which can be used without burning through the work, over-heating the electrode or producing a rough spattered surface. The table shows current ranges generally recommended for a general-purpose type 6013 electrode.

Electrode Size (ø mm)	Current Range (Amps)
2.6mm	60 - 100
3.2mm	100 - 130
4.0mm	130 - 165
5.0mm	165 - 260

Arc Length

To strike the arc, the electrode should be gently scraped on the work until the arc is established. An arc too long reduces penetration, produces spatter and gives a rough surface finish to the weld. An excessively short arc will cause sticking of the electrode and result in poor quality welds. The general rule of thumb for down hand welding is to have an arc length no greater than the diameter of the core wire.

Electrode Angle

The angle that the electrode makes with the work is important to ensure a smooth, even transfer of metal. When welding in down hand, fillet, horizontal or overhead, the angle of the electrode is generally between 5 and 15 degrees towards the direction of travel. When vertical up welding, the angle of the electrode should be between 80 and 90 degrees to the workpiece.

Travel Speed

The electrode should be moved along in the direction of the joint being welded at a speed that will give the size of run required. At the same time, the electrode is fed downwards to keep the correct arc length at all times. Excessive travel speeds lead to poor fusion, lack of penetration, etc., while too slow a rate of travel will frequently lead to arc instability, slag inclusions and poor mechanical properties.

Material and Joint Preparation

The material to be welded should be clean and free of any moisture, paint, oil, grease, mill scale, rust or any other material that will hinder the arc and contaminate the weld material. Joint preparation will depend on the method used include sawing, punching, shearing, machining, flame cutting and others. In all cases, edges should be clean and free of any contaminates. The chosen application will determine the type of joint.

SETUP FOR TIG

- 1 Connect the TIG torch to the **negative (-)** dinse connection, twist to lock in place. Plug torch connector in the 12-pin outlet.

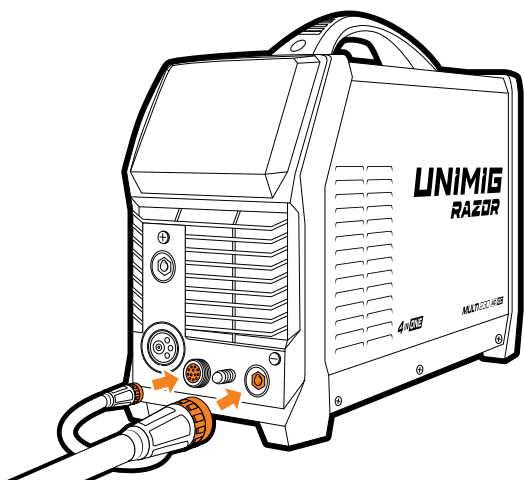

- 2 Connect the earth clamp to the **positive (+)** dinse connection, twist to lock in place.

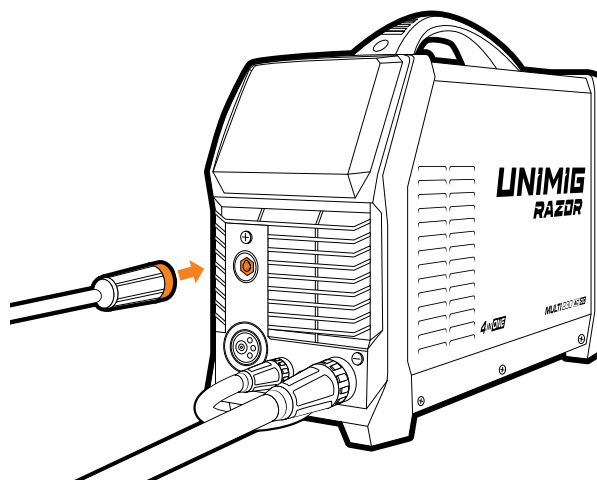

- 3 Connect the plug into a 15 AMP socket, then switch the machine ON.

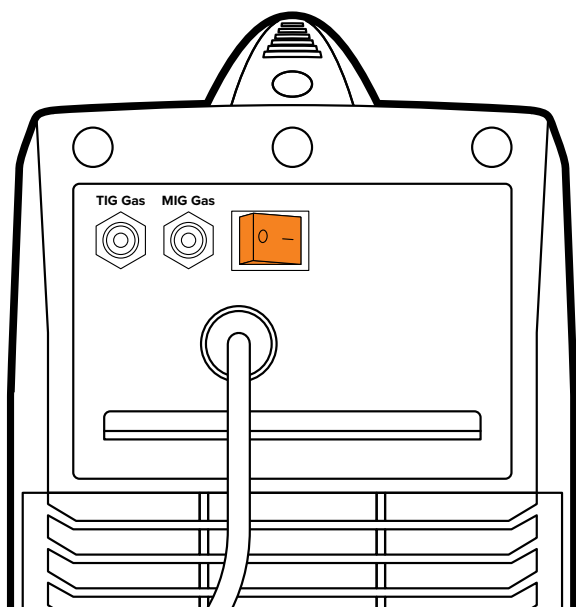

- 4 Connect gas hose to the TIG gas inlet on the rear of the machine.

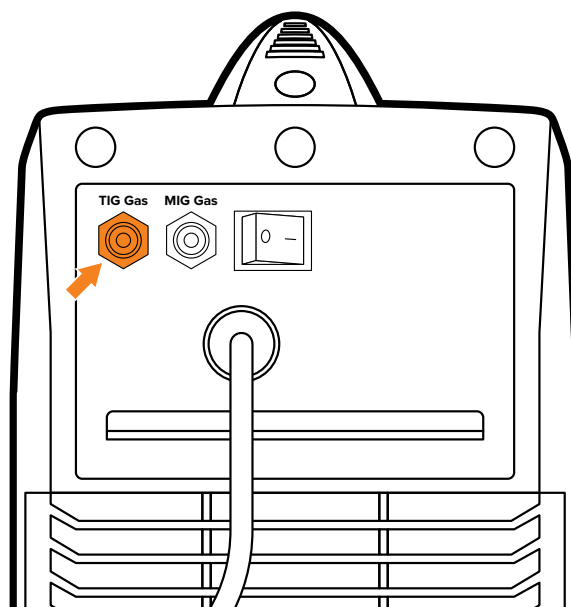

SETUP FOR TIG

- 5 Place twin gauge argon regulator into your gas outlet.

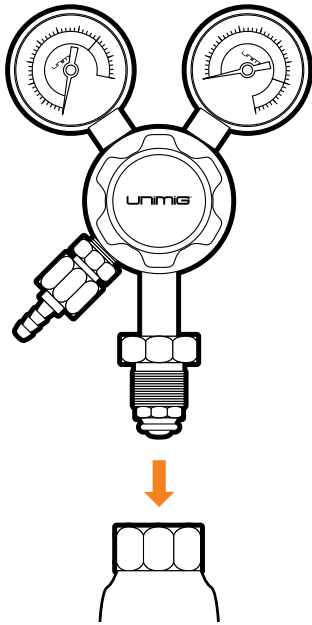

- 6 Tighten securely with wrench.

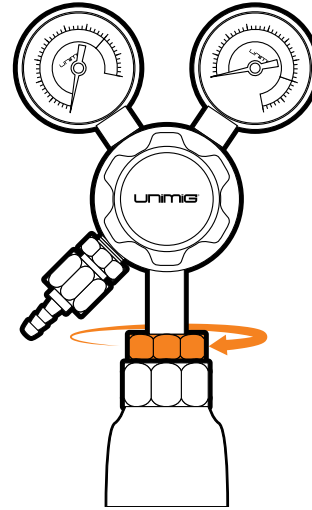

- 7 Connect gas hose to the regulator outlet, and crimp in place.

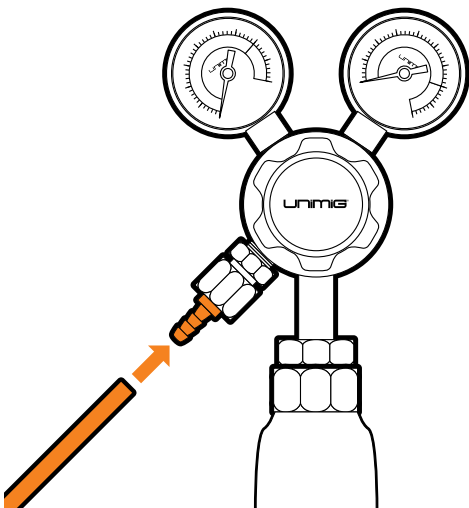

- 8 Adjust gas flow to 6-10L/min.

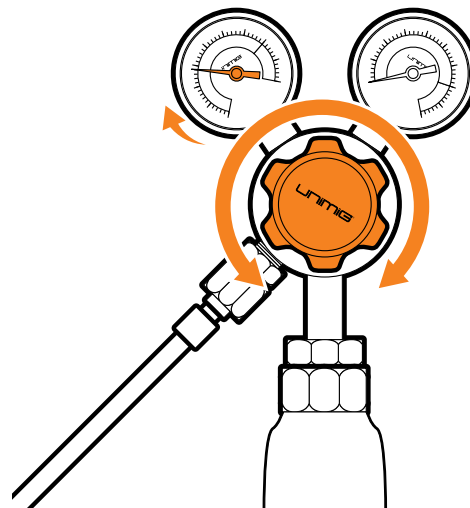

SETUP FOR TIG

- 9 Set weld parameters on the digital screen. See "Digital Screen - TIG" on page 18.

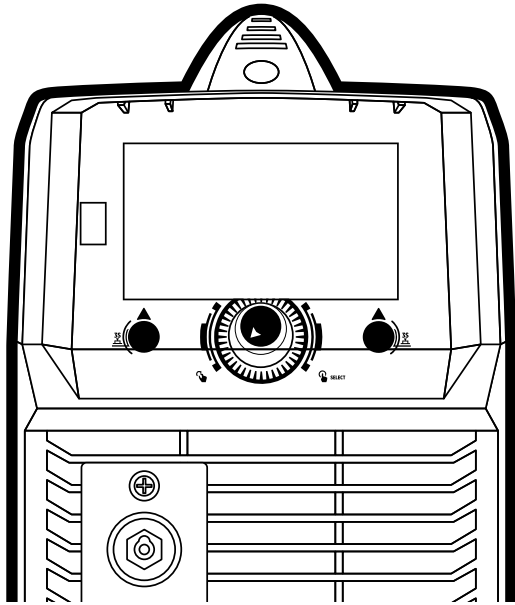

- 10 Connect earth clamp to your workpiece.

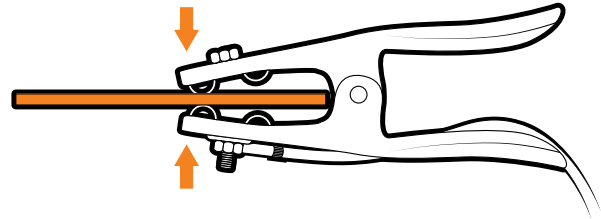

- 11 Initiate arc by pressing the button on the TIG Torch.

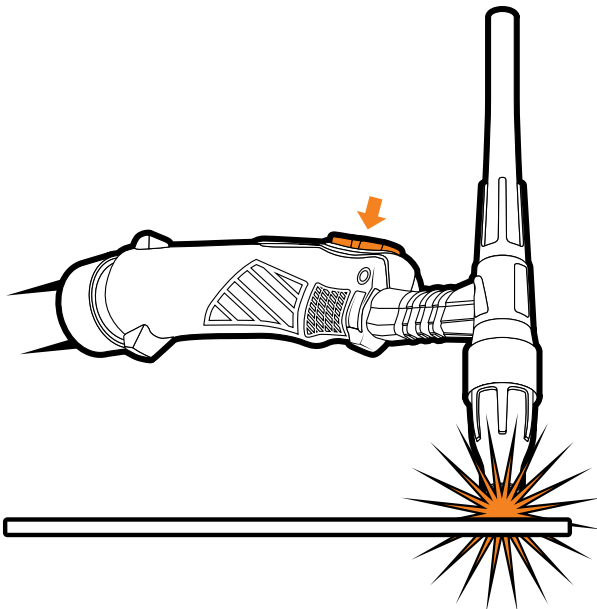

IMPORTANT! - We strongly recommend that you check for gas leakage prior to operation of your machine. We recommend that you close the cylinder valve when the machine is not in use.

Welding Guns Of Australia PTY LTD, authorised representatives or agents of Welding Guns Of Australia PTY LTD will not be liable or responsible for the loss of any gas.

AC Square Wave Frequency Control

It is possible with this machine to adjust the frequency of the AC Square Wave output. It means that the amount of time that it takes the AC square wave to complete a full cycle switch from positive (+) to negative (-) can be adjusted from 20Hz (20 times per second) to 200Hz

Increasing frequency (Hz) causes the current to change direction more often, which means that it spends less time per cycle in both DC electrode negative and DC electrode positive mode. By spending less time at each polarity, the arc cone has less time to expand.

A higher frequency produces a narrower arc cone producing an arc that is tighter with more focus at the exact spot the electrode is pointing. The result is improved arc stability, ideal for fillet welds and other fit ups requiring precise penetration. Decreasing the frequency softens the arc and broadens the weld pool producing a wider bead, produces good overall penetration and ideal for build up applications.

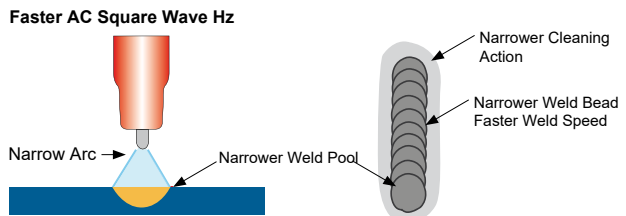
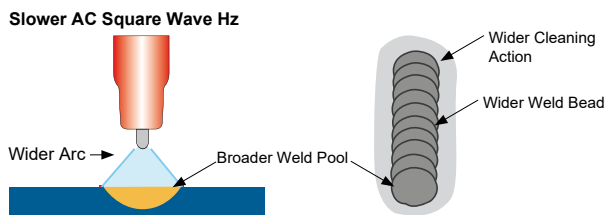
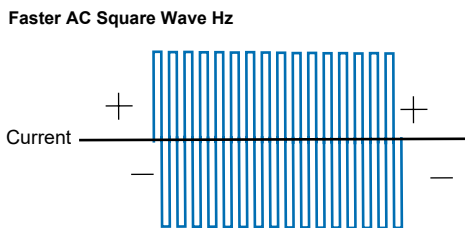
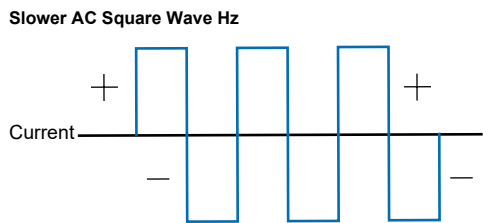
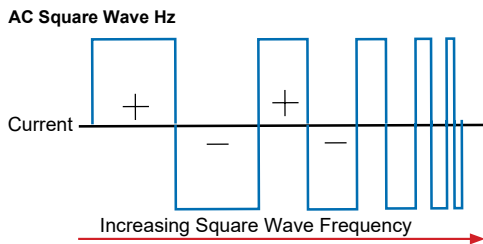

AC TIG WELDING GUIDE

AC (alternating current) enables us to TIG weld non ferrous alloys like Aluminium, Magnesium and Aluminium Alloys. These materials have an insulating surface oxide layer that melts at a higher temperature than the base metal making it difficult to weld the base metal if the oxides are not removed. AC welding current is ideal because the nature of the AC wave form assists in breaking the surface oxide layer.

AC (alternating current) has a current cycle that flows from + (direct) polarity to - (reverse) polarity.

The reversing of the polarity breaks the surface oxide while the direct polarity melts the base material.

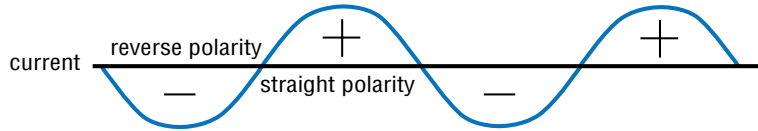

There are inherent problems that come with AC TIG arc rectification, arc stutter, arc wandering and arc stoppage. These problems typically occur during the transition between + and - cycles.

The current is lesser (30%) during the half of the cycle when the electrode is positive and there is a resistance of the electron flow during this half cycle (rectification). The lack of current flow during this half cycle makes the AC arc unstable.

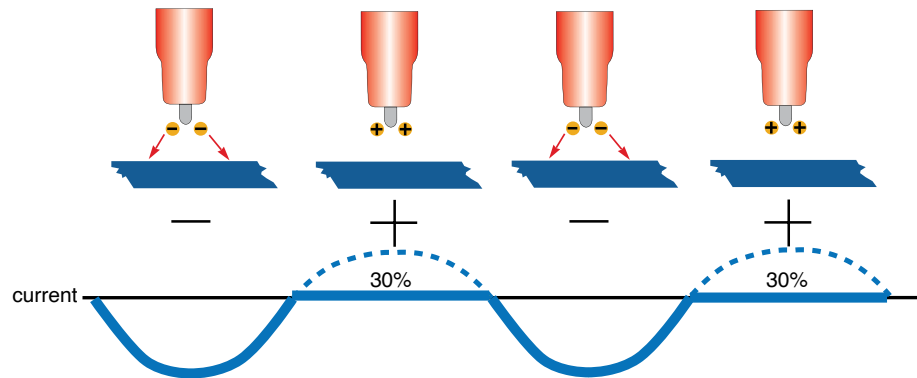

To overcome this lack of flow during one half of the cycle, a high-frequency (HF) voltage is generated and fed into the welding circuit. The HF maintains the arc stability during the half cycle when the electrode is positive.

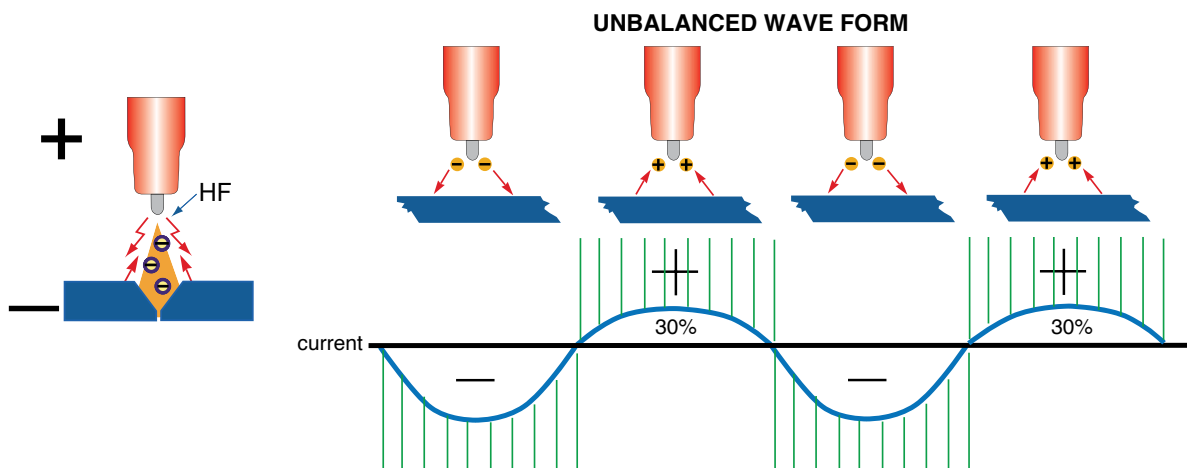

High-frequency voltage flows continually in the welding circuit and keeps the shielding arc in the welding area in an ionized state. When the arc is ionized the arc is maintained during the half of the cycle when the electrode is positive. However while the arc is maintained less current flows during this half of the AC cycle, producing an unbalanced wave.

AC TIG WELDING GUIDE

In older machines, a balanced current output wave was achieved using a large number of capacitors in series or a battery in the welding circuit. Modern TIG power sources use electronics to create and maintain a balanced wave and now most AC TIG power sources produce a square wave current output.

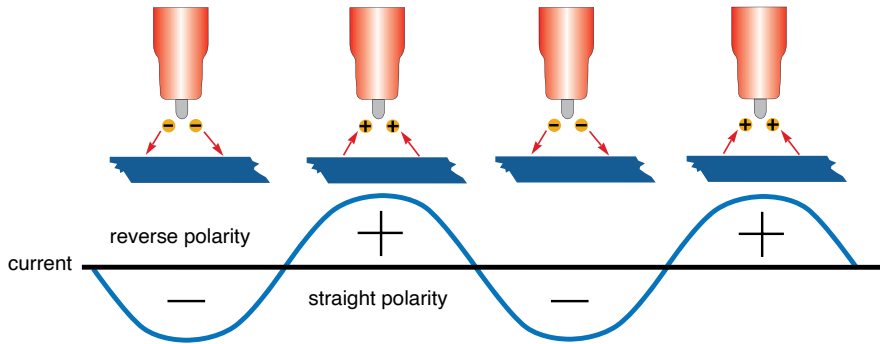

A square wave power supply can change the current from electrode + positive to electrode - negative very quickly. This produces high voltage as the current switches polarities allowing the arc to restart easily. The arc can be maintained without the use of high-frequency or any other arc stabilising methods.

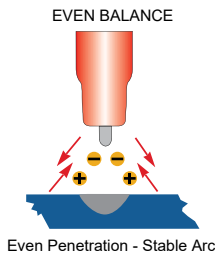

BALANCED SQUARE WAVE FORM

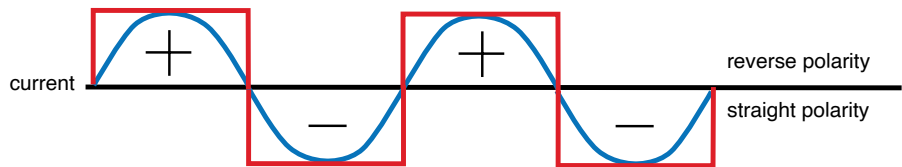

The output current and voltage are controlled electronically so the balance between the amount of current electrode positive and the amount of current electrode negative can be adjusted. This allows the welder to adjust the amount of cleaning and the amount of penetration. This is achieved electronically by adjusting the balance control dial on the welding machine. More current flow from the + polarity produces stronger arc energy and current flow from the tungsten and is good for removing the oxidized surface of the work piece. However too much + current flow can drive too much energy to the tungsten causing it to overheat and melt the tungsten electrode.

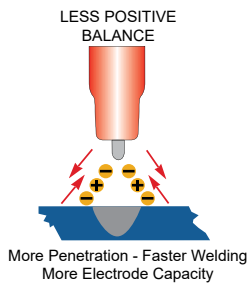

Balance Adjusted for More Penetration - Cooler Tungsten

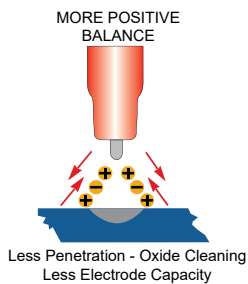
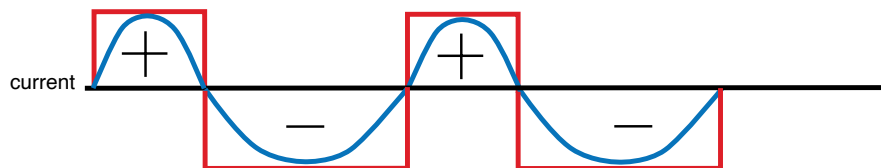

Balance Adjusted for More Oxide Cleansing Action - Hotter Tungsten

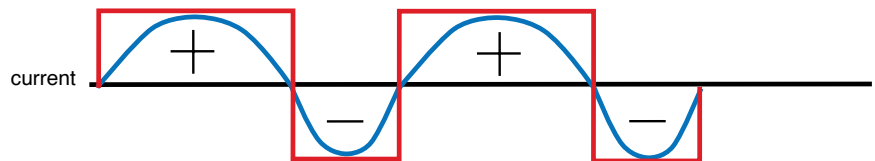

DC TIG Welding

The DC power source uses what is known as DC (direct current) in which the main electrical component known as electrons flow in only one direction from the negative pole (terminal) to the positive pole (terminal). In the DC electrical circuit, there is an electrical principle at work which should always be taken into account when using any DC circuit. With a DC circuit, 70% of the energy (heat) is always on the positive side. This needs to be understood because it determines what terminal the TIG torch will be connected to (this rule applies to all the other forms of DC welding as well).

DC TIG welding is a process in which an arc is struck between a tungsten electrode and the metal workpiece. The weld area is shielded by an inert gas flow to prevent contamination of the tungsten, molten pool and weld area. When the TIG arc is struck, the inert gas is ionised and superheated, changing its molecular structure, which converts it into a plasma stream. This plasma stream flowing between the tungsten and the workpiece is the TIG arc and can be as hot as 19,000°C. It is a very pure and concentrated arc which provides the controlled melting of most metals into a weld pool. TIG welding offers the user the highest amount of flexibility to weld the widest range of material thickness and types. DC TIG welding is also the cleanest weld with no sparks or spatter.

The intensity of the arc is proportional to the current that flows from the tungsten. The welder regulates the welding current to adjust the power of the arc. Typically thin material requires a less powerful arc with less heat to melt the material, so less current (amps) is required. Thicker material requires a more powerful arc with more heat, so more current (amps) are necessary to melt the material.

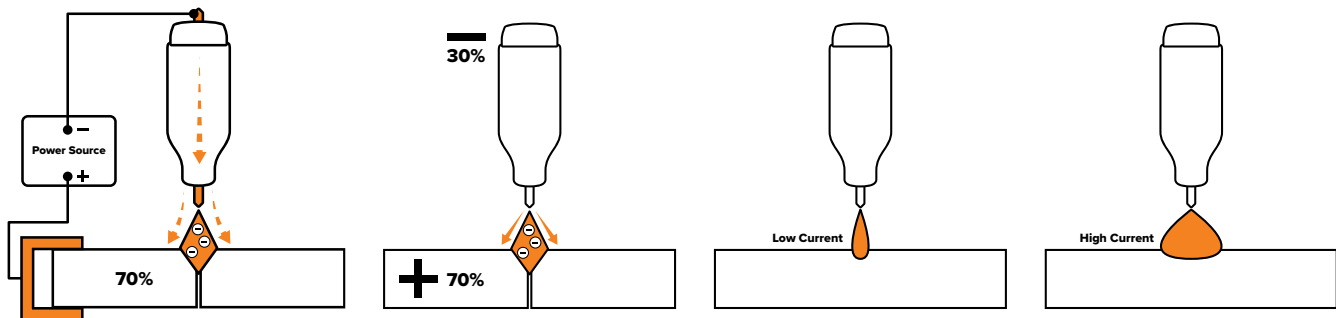

High Frequency Arc Ignition for TIG (Tungsten Inert Gas) Welding

HF (High Frequency) ignition allows the arc to be started in TIG welding without touching the tungsten to the work piece. By pressing the torch switch the machine will activate the gas flow and introduce the HF spark, this "ionises" the air gap making it conductive, allowing an arc to be created without touching the tungsten to the work piece. The gas molecules are superheated by the arc creating a stream of super heated gas that changes the molecular structure into producing a plasma stream. This plasma stream provides heat and energy that allows us to melt and fuse metals in an inert gas shielded environment know as TIG (Tungsten Inert Gas) welding.

Pulse DC TIG Welding

Pulse TIG welding is when the current output (amperage) changes between high and low current. Electronics within the welding machine create the pulse cycle. The high amperage is referred to as peak current, and the low amperage is referred to as base current. During pulse welding the weld pool cools during the low amperage period. This allows a lower overall heat input into the base metal. It allows for controlled heating and cooling periods during welding, providing better control of heat input, weld penetration, operator control and weld appearance.

There are 4 variables within the pulse cycle:

Peak Current - Base Current - Pulse Frequency - Pulse Width

Setting and manipulation of these variables will determine the nature of the weld current output and is at the discretion of the operator.

Peak Current is the main welding current (amps) set to melt the material being welded and works much the same as setting maximum amperage values for regular DC TIG: as a general guide use 30-40 amps for every 1mm of material thickness.

Base Current is the set level of background current (amps) which cools the weld puddle and effects overall heat input. As a rule, use enough background current to reduce the weld pool to about half its normal size while still keeping the weld pool fluid. As a guide start by setting the background amperage at 20 to 30 percent of peak amperage.

Pulse Frequency controls the amount of times per second (Hz) that the welding current switches from Peak Current to Base Current. DC Pulse TIG frequency generally ranges from 20 to 300 HZ depending on the job application. Control of the pulse frequency also determines the appearance of the weld.

Pulse Width is the control of the on time of the peak amp. It is the percentage of time the peak amp is on during one pulsing cycle. Example: with the pulse width set at 80%, the machine will spend 80% of the pulse at peak amperage and 20% at the base amperage. Increasing the pulse width percentage adds more heat to the job, while decreasing pulse width percentage reduces heat.

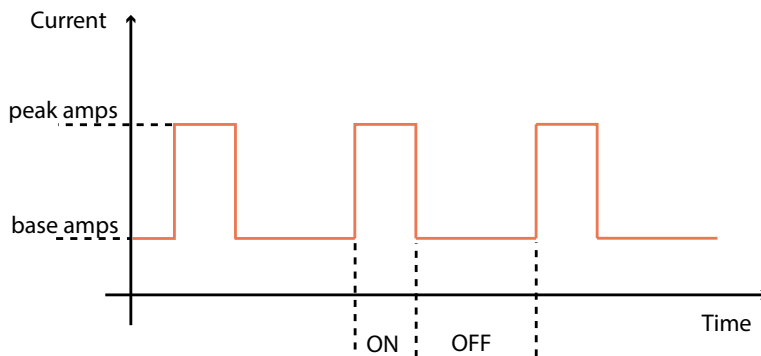

DC Pulse TIG welding allows faster welding speeds with better control of the heat input to the job, reducing the heat input minimising distortion and warping of the work and is of particular advantage in the welding of thin stainless steel and carbon steel applications. The high pulse frequency capability of the advanced inverter agitates the weld puddle and allows you to move quickly without transferring too much heat to the surrounding metal. Pulsing also constricts and focuses the arc, increasing arc stability, penetration and travel speeds.

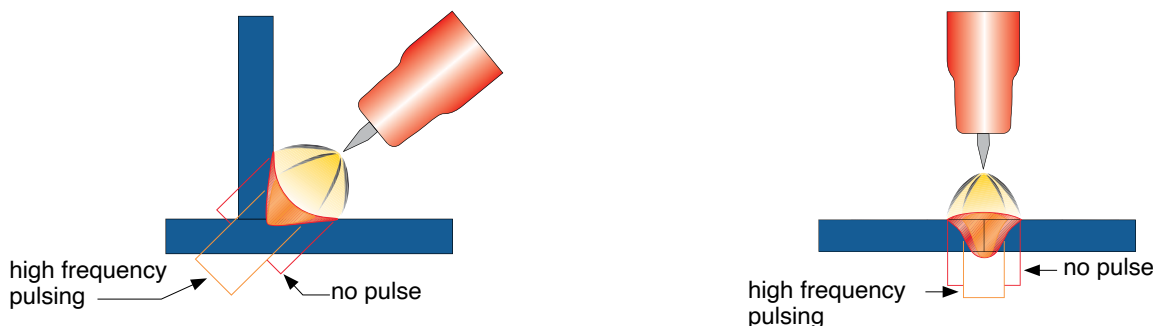

TIG Welding Fusion Technique

Manual TIG welding is often considered the most difficult of all the welding processes. Because the welder must maintain a short arc length, great care and skill are required to prevent contact between the electrode and the workpiece. Similar to Oxygen Acetylene torch welding, TIG welding typically requires two hands and in most instances requires the welder to manually feed a filler wire into the weld pool with one hand while manipulating the welding torch in the other. However, some welds combining thin materials can be accomplished without filler metal, such as edge, corner, and butt joints. This is known as Fusion welding where the edges of the metal pieces are melted together using only the heat and arc force generated by the TIG arc. Once the arc is started, the torch tungsten is held in place until a weld pool is created, a circular movement of the tungsten will assist in creating a weld pool of the desired size. Once the weld pool is established, tilt the torch at about a 75° angle and move smoothly and evenly along the joint while fusing the materials together.

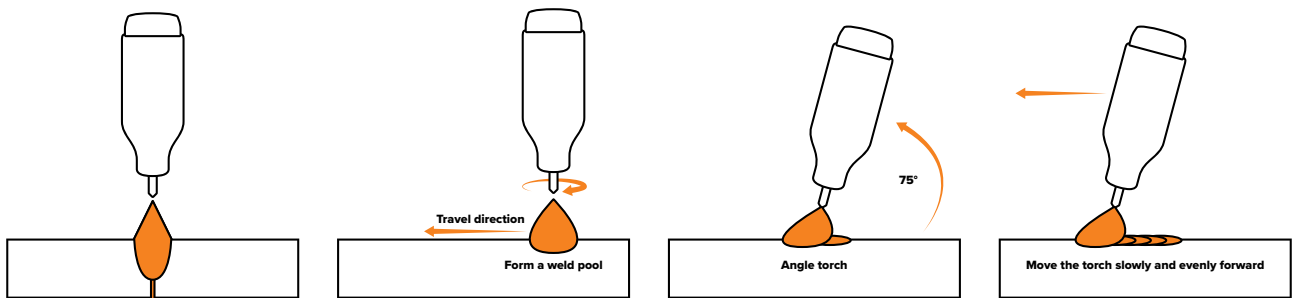

TIG Welding with Filler Wire Technique

It is necessary for many situations with TIG welding to add a filler wire into the weld pool to build up weld reinforcement and create a strong weld. Once the arc is started, the torch tungsten is held in place until a weld pool is created, a circular movement of the tungsten will assist in creating a weld pool of the desired size. Once the weld pool is established, tilt the torch at about a 75° angle and move smoothly and evenly along the joint. The filler metal is introduced to the leading edge of the weld pool. The filler wire is usually held at about a 15° angle and fed into the leading edge of the molten pool. The arc will melt the filler wire into the weld pool as the torch is moved forward. Also, a dabbing technique can be used to control the amount of filler wire added. The wire is fed into the molten pool and retracted in a repeating sequence as the torch is moved slowly and evenly forward. It is essential during the welding to keep the molten end of the filler wire inside the gas shield as this protects the end of the wire from being oxidised and contaminating the weld pool.

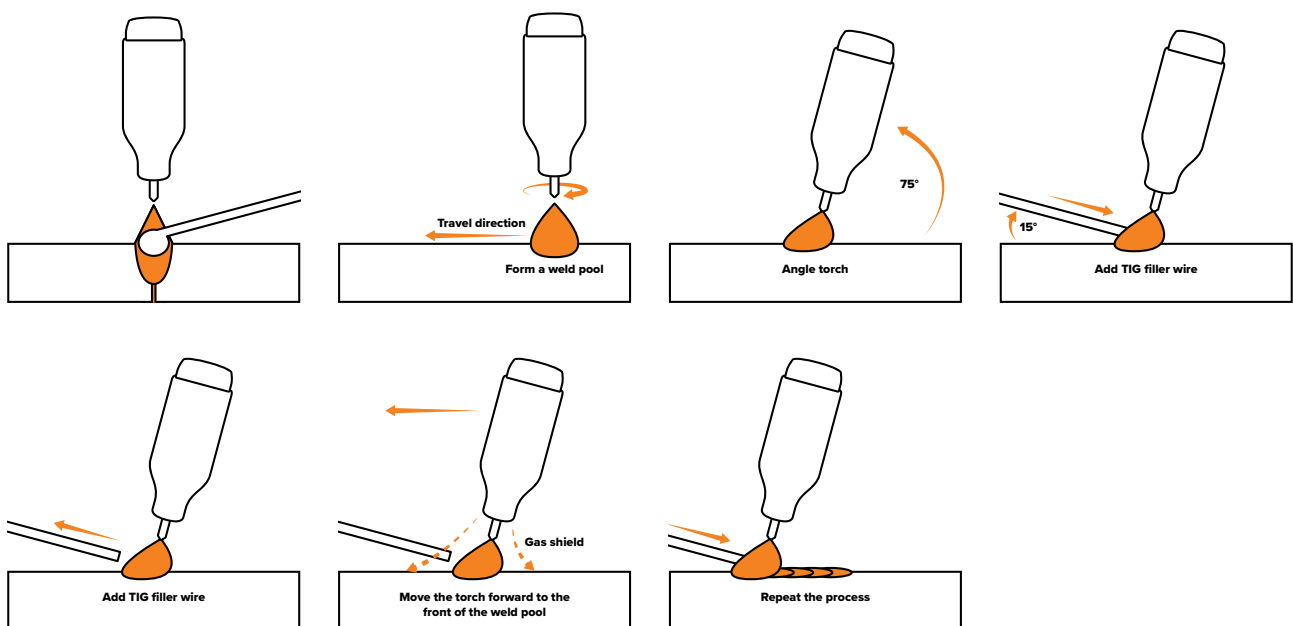

Tungsten Electrodes

- Tungsten is a rare metallic element used for manufacturing TIG welding electrodes. The TIG process relies on tungsten's hardness and high-temperature resistance to carry the welding current to the arc. Tungsten has the highest melting point of any metal, 3,410 degrees Celsius.
- Tungsten electrodes are non-consumable and come in a variety of sizes. They are made from pure tungsten or an alloy of tungsten and other rare earth elements. Choosing the correct tungsten depends on the material being welded, the number of amps required and whether you are using AC or DC welding current.
- Tungsten electrodes are colour-coded at the end for easy identification.
- Below are the most commonly used tungsten electrodes found in the New Zealand and Australian market.

Thoriated (Colour Code: Red)

Thoriated tungsten electrodes (AWS classification EWTh-2) contain a minimum of 97.30 % tungsten and 1.70 to 2.20 % thorium and are called 2 % thoriated. They are the most commonly used electrodes today and are preferred for their longevity and ease of use. Thorium, however, is a low-level radioactive hazard and many users have switched to other alternatives. Regarding the radioactivity, thorium is an alpha emitter, but when it is enclosed in a tungsten matrix, the risks are negligible. Thoriated tungsten should not get in contact with open cuts or wounds. The more significant danger to welders can occur when thorium oxide gets into the lungs. This can happen from the exposure to vapours during welding or ingestion of material/dust in the grinding of the tungsten. Follow the manufacturer's warnings, instructions, and the Material Safety Data Sheet (MSDS) for its use.

Rare Earth (Colour Code: Purple)

Rare Earth tungsten electrodes (AWS classification EWG) contain a minimum of 98% % tungsten and up to 1.5 % Lanthanum and small percentages of zirconium and yttrium they are called Rare Earth tungsten. Rare Earth tungsten electrodes provide conductivity similar to that of thoriated electrodes. Typically, this means that Rare Earth tungsten electrodes are exchangeable with thoriated electrodes without requiring significant welding process changes. Rare Earth delivers superior arc starting, electrode lifetime, and overall cost-effectiveness. When Rare Earth tungsten electrodes are compared with 2% thoriated tungsten, Rare Earth requires fewer re-grinds and provides a longer overall lifetime. Tests have shown that ignition delay with Rare Earth tungsten electrodes improve over time, while 2% thoriated tungsten starts to deteriorate after only 25 starts. At equivalent energy output, Rare Earth tungsten electrodes run cooler than 2% thoriated tungsten, thereby extending overall tip lifetime. Rare Earth tungsten electrodes work well on AC or DC. They can be used DC electrode positive or negative with a pointed end, or balled for use with AC power sources.

Ceriated (Colour Code: Orange)

Ceriated tungsten electrodes (AWS classification EWCe-2) contain a minimum of 97.30% tungsten and 1.80 to 2.20% cerium and are referred to as 2% ceriated. Ceriated tungstens perform best in DC welding at low current settings. They have excellent arc starts at low amperages and become popular in such applications as orbital tube welding and thin sheet metal work. They are best used to weld carbon steel, stainless steel, nickel alloys, and titanium. In some cases, it can replace 2% thoriated electrodes. Ceriated tungsten is best suited for lower amperages it should last longer than a Thoriated tungsten. Higher amperage applications are best left to Thoriated or Lanthanated tungstens.

Lanthanated (Colour Code: Gold)

Lanthanated tungsten electrodes (AWS classification EWLan-1.5) contain a minimum of 97.80 % tungsten and 1.30 % to 1.70 % lanthanum and are known as 1.5 % lanthanated. These electrodes have excellent arc starting, a low burn-off rate, good arc stability, and excellent re-ignition characteristics. Lanthanated tungstens also share the conductivity characteristics of 2 % thoriated tungsten. Lanthanated tungsten electrodes are ideal if you want to optimise your welding capabilities. They work well on AC or DC electrode negative with a pointed end, or they can be balled for use with AC sine wave power sources. Lanthanated tungsten maintains a sharpened point well, which is an advantage for welding steel and stainless steel on DC or AC from square wave power sources.

Zirconiated (Colour Code: White)

Zirconiated tungsten electrodes (AWS classification EWZr-1) contain a minimum of 99.10 % tungsten and 0.15 to 0.40 % zirconium. Most commonly used for AC welding, Zirconiated tungsten produces a very stable arc and is resistant to tungsten spitting. It is ideal for AC welding because it retains a balled tip and has a high resistance to contamination. Its current-carrying capacity is equal to or greater than that of thoriated tungsten. Zirconiated tungsten is not recommended for DC welding.

Tungsten Electrodes Rating for Welding Currents

Tungsten Diameter (mm)	Diameter at the Tip (mm)	Constant Included Angle (°)	Current Range (Amps)	Current Range (Pulsed Amps)
1.0mm	0.25	20	5 - 30	5 - 60
1.6mm	0.5	25	8 - 50	5 - 100
1.6mm	0.8	30	10 - 70	10 - 140
2.4mm	0.8	35	12 - 90	12 - 180
2.4mm	1.1	45	15 - 150	15 - 250
3.2mm	1.1	60	20 - 200	20 - 300
3.2mm	1.5	90	25 - 250	25 - 350

Tungsten Preparation

Always use DIAMOND wheels when grinding and cutting. While tungsten is a tough material, the surface of a diamond wheel is harder, and this makes for smooth grinding. Grinding without diamond wheels, such as aluminium oxide wheels, can lead to jagged edges, imperfections, or poor surface finishes not visible to the eye that will contribute to weld inconsistency and weld defects.

Always ensure to grind the tungsten in a longitudinal direction on the grinding wheel. Tungsten electrodes are manufactured with the molecular structure of the grain running lengthwise and thus grinding crosswise is "grinding against the grain." If electrodes are ground crosswise, the electrons have to jump across the grinding marks, and the arc can start before the tip and wander. Grinding longitudinally with the grain causes the electrons to flow steadily and easily to the end of the tungsten tip. The arc starts straight and remains narrow, concentrated, and stable.

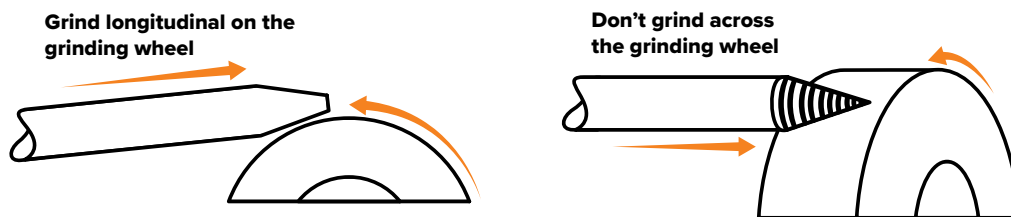

Electrode Tip/Flat

The shape of the tungsten electrode tip is an important process variable in precision arc welding. A good selection of tip/flat size will balance the need for several advantages. The bigger the flat, the more likely arc wander will occur and the more difficult it will be to arc start. However, increasing the flat to the maximum level that still allows arc starts and eliminates arc wander will improve the weld penetration and increase the electrode life. Some welders still grind electrodes to a sharp point, which makes arc starting easier. However, they risk decreased welding performance from melting at the tip and the possibility of the point falling off into the weld pool.



Electrode Included Angle/Taper - DC

Tungsten electrodes for DC welding should be ground longitudinally and concentrically with diamond wheels to a specific included angle in conjunction with the tip/flat preparation. Different angles produce different arc shapes and offer different weld penetration capabilities. In general, blunter electrodes that have a larger included angle provide the following benefits:

- Last longer
- Have better weld penetration
- Have a narrower arc shape
- Can handle more amperage without eroding

Sharper electrodes with a smaller included angle provides:

- Offer less arc weld
- Have a wider arc
- Have a more consistent arc

The included angle determines the weld bead shape and size. Generally, as the included angle increases, penetration increases and bead width decreases.



M24 BINZEL Style MIG Torch

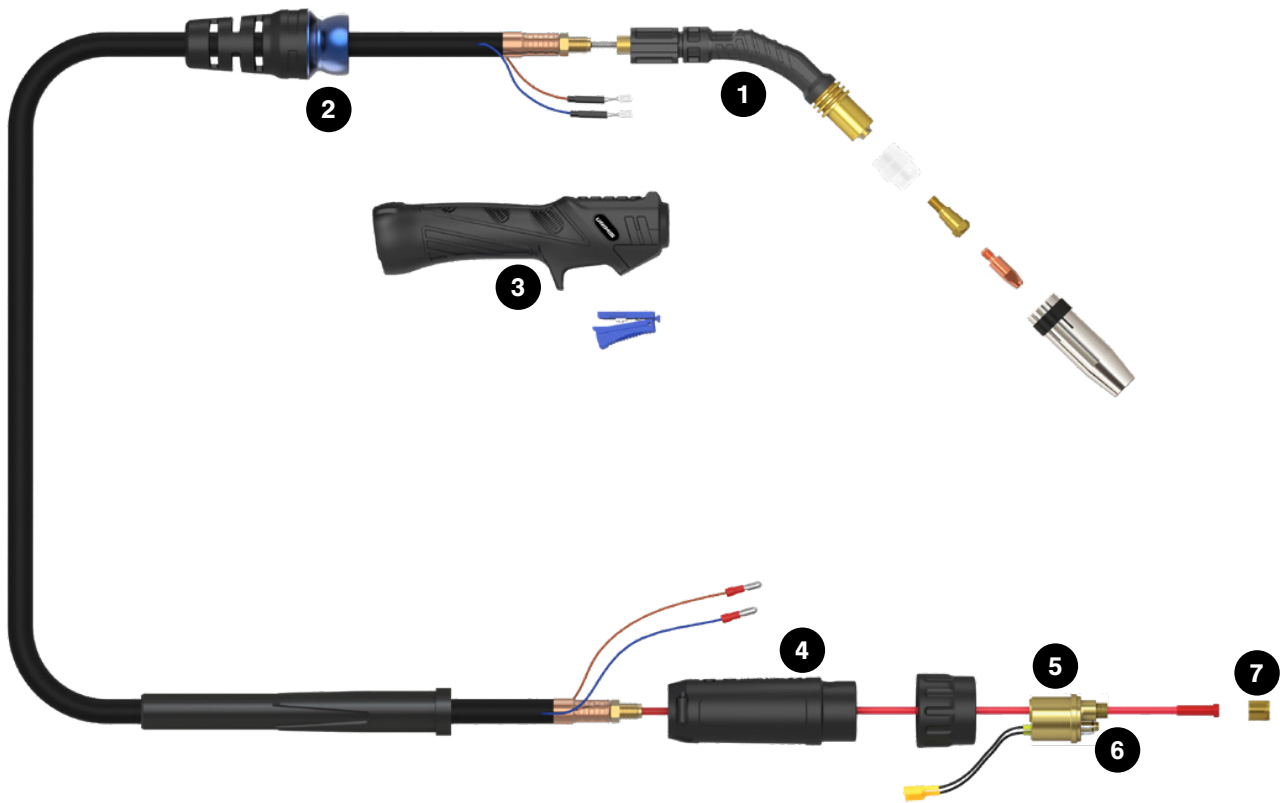

Length	3m	4m	5m
SKU	SB24-3M	SB24-4M	SB24-5M

TORCH SPARES		
1	U41013	M24 Swan Neck
2	AM1514	Handle Cable Support c/w Ball Joint
3	AM2514	Handle Kit
4	AM2578/L	Gun Plug Housing
5	UB1528	Hybrid Gun Plug Body C/W Spring Pins
6	UB1524	Gun Plug 'O' Ring
7	UB1525	Liner Nut

TECHNICAL DATA	
COOLING METHOD	Air Cooled
DUTY CYCLE - CO2	60% @ 250A
DUTY CYCLE - MIXED GAS	60% @ 220A
WIRE SIZE	0.6-1.2mm
LENGTHS (m)	3/4/5
STANDARD	EN60974-7

M24 MIG Torch Consumables



SKU	Description	QTY
PCTH24	TIP HOLDER	2



SKU	Description	QTY
PCGD24	Gas Diffuser	2



SKU	Description	QTY
PCT0009-06	CONTACT TIPS - Steel 0.6mm	10
PCT0009-08	CONTACT TIPS - Steel 0.8mm	10
PCT0009-09	CONTACT TIPS - Steel 0.9mm	10
PCT0009-10	CONTACT TIPS - Steel 1.0mm	10
PCT0009-12	CONTACT TIPS - Steel 1.2mm	10
PCTAL0009-09	CONTACT TIPS - Aluminium 0.9mm	10
PCTAL0009-10	CONTACT TIPS - Aluminium 1.0mm	10
PCTAL0009-12	CONTACT TIPS - Aluminium 1.2mm	10



SKU	Description	QTY
PGN24CON	GAS NOZZLE - Conical	2
PGN24CYL	GAS NOZZLE - Cylindrical	2
PGN24TAP	GAS NOZZLE - Tapered	2

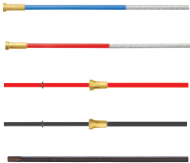

SKU	Description	Wire Size
SLB3M	Blue Steel Liner 3 Metre	0.6 - 0.8mm
SLB4M	Blue Steel Liner 4 Metre	0.6 - 0.8mm
SLB5M	Blue Steel Liner 5 Metre	0.6 - 0.8mm
SLR3M	Red Steel Liner 3 Metre	0.9 - 1.2mm
SLR4M	Red Steel Liner 4 Metre	0.9 - 1.2mm
SLR5M	Red Steel Liner 5 Metre	0.9 - 1.2mm
TLB3M	Blue Aluminium Liner 3 Metre	0.6 - 0.8mm
TLB4M	Blue Aluminium Liner 4 Metre	0.6 - 0.8mm
TLR3M	Red Aluminium Liner 3 Metre	0.9 - 1.2mm
TLR4M	Red Aluminium Liner 4 Metre	0.9 - 1.2mm
TLY3M	Yellow Aluminium Liner 3 Metre	1.2 - 1.6mm
TLY4M	Yellow Aluminium Liner 4 Metre	1.2 - 1.6mm
NKSTL	Neck Spring for Aluminium	

MIG DRIVE ROLLERS

Drive Roller Selection

The importance of smooth, consistent wire feeding during MIG welding cannot be emphasised enough. The smoother the wire feed, the better the welding will be. Feed rollers or drive rollers are used to feed the wire mechanically along the length of the welding gun.

Feed rollers are designed to be used for certain types of welding wire, and they have different types of grooves machined in them to accommodate the different types of wire. The wire is held in the groove by the top roller of the wire drive unit and is referred to as the pressure roller. Pressure is applied by a tension arm that can be adjusted to increase or decrease the pressure as required. The type of wire will determine how much pressure can be applied and what type of drive roller is best suited to obtain optimum wire feed.

Solid Hard Wire (V Groove)

Steel or stainless steel require a drive roller with a **V** shape groove for optimum grip and drive capability. Solid wires can have more tension applied to the wire from the top pressure roller that holds the wire in the groove, and the V shape groove is more suited for this. Solid wires are more forgiving to feed due to their higher cross-sectional column strength. They are stiffer and don't bend so easily.

Aluminium (U Groove)

Aluminium requires a **U** shape groove. Aluminium wire has a lot less column strength, can bend easily and is, therefore, more difficult to feed. Soft wires can easily buckle at the wire feeder where the wire is fed into inlet guide tube of the torch. The U-shaped roller offers more surface area grip and traction to help feed the softer wire. Softer wires also require less tension from the top pressure roller to avoid deforming the shape of the wire, too much tension will push the wire out of shape and cause it to catch in the contact tip.

Flux Cored / Gasless Wire (Knurled/F Groove)

These wires are made up of a thin metal sheath that has fluxing, and metal compounds layered onto it and then rolled into a cylinder to form the finished wire. The wire cannot take too much pressure from the top roller as it can be crushed and deformed if too much pressure is applied. A **Knurled/F** groove drive roller has been developed, and it has small serrations in the groove. The serrations grip the wire and assist in driving it without too much pressure from the top roller. The downside to the knurled wire feed roller on flux-cored wire is it will slowly over time bit by bit eat away at the surface of the welding wire, and these small pieces will eventually go down into the liner. This will cause clogging in the liner and added friction that will lead to welding wire feed problems. A U groove wire can also be used for flux core wire without the wire particles coming off the wire surface. However, it is considered that the knurled roller will give a more positive feed of flux core wire without any deformation of the wire shape.

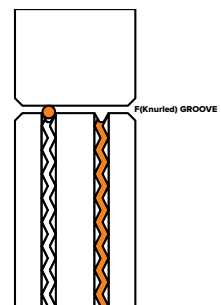
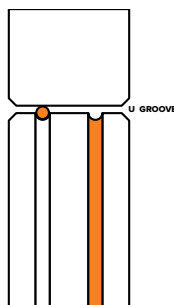
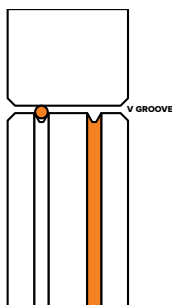

Roller Diameter: 30/22

V Groove Roller (Steel Wire)

SKU	Description
0.6-0.8V30/22	Drive Roll V Groove 0.6-0.8mm
0.8-1.0V30/22	Drive Roll V Groove 0.8-1.0mm
0.9-1.2V30/22	Drive Roll V Groove 0.9-1.2mm
1.0-1.2V30/22	Drive Roll V Groove 1.0-1.2mm

U Groove Roller (Aluminium Wire)

SKU	Description
0.8-1.0U30/22	Drive Roll U Groove 0.8-1.0mm
0.9-1.0U30/22	Drive Roll U Groove 0.9-1.0mm
0.9-1.2U30/22	Drive Roll U Groove 0.9-1.2mm
1.0-1.2U30/22	Drive Roll U Groove 1.0-1.2mm

Knurled/F Groove (Flux-Cored Wire)

SKU	Description
0.8-0.9F30/22	Drive Roll Knurled 0.8-0.9mm
0.9-1.2F30/22	Drive Roll Knurled 0.9-1.2mm

WARNING: There are extremely dangerous voltage and power levels present inside this unit. Do not attempt to diagnose or repair unit by removing external cover unless you are an authorised repair agent for UNIMIG.

MIG TROUBLESHOOTING

1. Excessive Spatter

- **Wire feed speed set too high:** Select lower wire feed speed.
- **Voltage too high:** Select a lower voltage setting.
- **Wrong polarity set:** Select the correct polarity for the wire being used - see machine setup guide.
- **Stick out too long:** Bring the torch closer to the work.
- **Contaminated base metal:** Remove materials like paint, grease, oil, and dirt, including mill scale from base metal.
- **Contaminated MIG wire:** Use clean, dry, rust-free wire. Do not lubricate the wire with oil, grease etc.
- **Inadequate gas flow or too much gas flow:** Check the gas is connected, check hoses, gas valve and torch are not restricted. Set the gas flow between 8-12 L/min flow rate. Check hoses and fittings for holes, leaks etc.

2. Porosity - Small cavities or holes resulting from gas pockets in weld metal

- **Wrong gas:** Check that the correct gas is being used.
- **Inadequate gas flow or too much gas flow:** Check the gas is connected, check hoses, gas valve and torch are not restricted. Set the gas flow between 8-12 L/min flow rate. Check hoses and fittings for holes, leaks etc. Protect the welding zone from wind and drafts.
- **Moisture on the base metal:** Remove all moisture from base metal before welding.
- **Contaminated base metal:** Remove materials like paint, grease, oil, and dirt, including mill scale from base metal.
- **Contaminated MIG wire:** Use clean, dry, rust-free wire. Do not lubricate the wire with oil, grease etc.
- **Gas nozzle clogged with spatter, worn or out of shape:** Clean or replace the gas nozzle.
- **Missing or damaged gas diffuser:** Replace the gas diffuser.
- **MIG torch Euro connect O-ring missing or damaged:** Check and replace the O-ring.

3. Wire stubbing during welding

- **Holding the torch too far away:** Bring the torch closer to the work and maintain stick out of 5-10mm.
- **Welding voltage set too low:** Increase the voltage.
- **Wire feed speed set too high:** Decrease the wire feed speed.

4. Lack of fusion - Failure of weld metal to fuse completely with base metal or a proceeding weld bead

- **Contaminated base metal:** Remove materials like paint, grease, oil, and dirt, including mill scale from base metal.
- **Not enough heat input:** Select a higher voltage range and/or adjust the wire speed to suit.
- **Improper welding technique:** Keep the arc at the leading edge of the weld pool. Gun angle to work should be between 5° & 15°. Direct the arc at the weld joint. Adjust work angle or widen groove to access bottom during welding. Momentarily hold arc on side walls if using weaving technique.

5. Excessive penetration - Weld metal melting through base metal

- **Too much heat:** Select a lower voltage range and/or adjust the wire speed to suit. Increase travel speed.

6. Lack of penetration - Shallow fusion between weld metal and base metal

- **Poor or incorrect joint preparation:** Material too thick. Joint preparation and design needs to allow access to bottom of groove while maintaining proper welding wire extension and arc characteristics. Keep the arc at the leading edge of the weld pool and maintain the gun angle at 5° & 15° keeping the stick out between 5-10mm.
- **Not enough heat input:** Select a higher voltage range and/or adjust the wire speed to suit. Reduce travel speed.
- **Contaminated base metal:** Remove materials like paint, grease, oil, and dirt, including mill scale, from base metal.

7. No wire feed

- **Wrong mode selected:** Check that the TIG/MMA/MIG selector switch is set to MIG position.
- **Wrong torch selector switch:** Check that the STANDARD/SPOOL GUN selector switch is set to STANDARD position for MIG welding and SPOOL GUN when using the spool gun.

8. Inconsistent/interrupted wire feed

- **Adjusting wrong dial:** Be sure to adjust the WIRE FEED and VOLTAGE dials for MIG welding. The AMPERAGE dial is for STICK and TIG welding mode.
- **Wrong polarity selected:** Select the correct polarity for the wire being used - see machine setup guide.
- **Incorrect wire speed setting:** Adjust the wire feed speed.
- **Voltage setting incorrect:** Adjust the voltage setting.
- **MIG torch lead too long:** Small diameter wires and soft wires like aluminium don't feed well through long torch leads - replace the torch with a lesser length torch.
- **MIG torch lead kinked or too sharp angle being held:** Remove the kink, reduce the angle or bend.
- **Contact tip worn, wrong size, wrong type:** Replace the tip with correct size and type.
- **Liner worn or clogged (the most common causes of bad feeding):** Try to clear the liner by blowing out with compressed air as a temporary cure. It is recommended to replace the liner.
- **Wrong size liner:** Install the correct size liner.
- **Blocked or worn inlet guide tube:** Clear or replace the inlet guide tube.
- **Wire misaligned in drive roller groove:** Locate the wire into the groove of the drive roller.
- **Incorrect drive roller size:** Fit the correct size drive roller e.g. 0.8mm wire requires 0.8mm drive roller.
- **Wrong type of drive roller selected:** Fit the correct type roller (e.g. knurled rollers needed for flux cored wires).
- **Worn drive rollers:** Replace the drive rollers.
- **Drive roller pressure too high:** Can flatten the wire electrode causing it to lodge in the contact tip - reduce the drive roller pressure.
- **Too much tension on wire spool hub:** Reduce the spool hub brake tension.
- **Wire crossed over on the spool or tangled:** Remove the spool, untangle the wire or replace the wire.
- **Contaminated MIG wire:** Use clean, dry, rust-free wire. Do not lubricate the wire with oil, grease etc.

TIG TROUBLESHOOTING

1. Tungsten burning away quickly

- **Incorrect gas or no gas:** Use pure argon. Check cylinder has gas is connected, turned on and torch valve is open.
- **Inadequate gas flow:** Check the gas is connected, check hoses, gas valve and torch are not restricted.
- **Back cap not fitted correctly:** Make sure the torch back cap is fitted so that the O-ring is inside the torch body.
- **Torch connected to DC+:** Connect the torch to the DC- output terminal.
- **Incorrect tungsten being used:** Check and change the tungsten type if necessary.
- **Tungsten being oxidised after weld is finished:** Keep shielding gas flowing 10-15 seconds after arc stoppage. 1 second for each 10 amps of weld current.

2. Contaminated tungsten

- **Touching tungsten into the weld pool:** Keep tungsten from contacting weld puddle. Raise the torch so that the tungsten is off of the work piece 2-5mm.
- **Touching the filler wire to the tungsten:** Keep the filler wire from touching the tungsten during welding, feed the filler wire into the leading edge of the weld pool in front of the tungsten.

3. Porosity - Poor weld appearance and colour

- **Wrong gas / poor gas flow / gas leaks:** Use pure argon. Gas is connected, check hoses, gas valve and torch are not restricted. Set the gas flow between 6-12 L/min. Check hoses and fittings for holes, leaks etc.
- **Contaminated base metal:** Remove moisture and materials like paint, grease, oil, and dirt from base metal.
- **Contaminated filler wire:** Remove all grease, oil, or moisture from filler metal.
- **Incorrect filler wire:** Check the filler wire and change if necessary.

4. Yellowish residue/smoke on the alumina nozzle & discoloured tungsten

- **Incorrect gas:** Use pure argon gas.
- **Inadequate gas flow:** Set the gas flow between 6-10 L/min flow rate.
- **Alumina gas nozzle too small:** Increase the size of the alumina gas nozzle.

5. Unstable arc during DC welding

- **Torch connected to DC+.** Connect the torch to the DC- output terminal.
- **Contaminated base metal.** Remove materials like paint, grease, oil, and dirt, including mill scale from base metal.
- **Tungsten is contaminated.** Remove 10mm of contaminated tungsten and re-grind the tungsten.
- **Arc length too long.** Lower torch so that the tungsten is off of the work piece 2-5mm.

6. Arc wanders during DC welding

- **Poor gas flow:** Check and set the gas flow between 6-10 L/min flow rate.
- **Incorrect arc length:** Lower torch so that the tungsten is off of the work piece 2-5mm.
- **Tungsten incorrect or in poor condition:** Check that correct type of tungsten is being used. Remove 10mm from the weld end of the tungsten and re-sharpen the tungsten.
- **Poorly prepared tungsten:** Grind marks should run lengthwise with tungsten, not circular. Use proper grinding method and wheel.
- **Contaminated base metal or filler wire:** Remove contaminating materials like paint, grease, oil, and dirt, including mill scale, from base metal. Remove all grease, oil, or moisture from filler metal.

7. Arc difficult to start or will not start DC welding

- **Incorrect machine set up:** Check machine set up is correct.
- **No gas, incorrect gas flow:** Check the gas is connected and cylinder valve open, check hoses, gas valve and torch are not restricted. Set the gas flow between 6-10 L/min flow rate.
- **Incorrect tungsten size or type:** Check and change the size and or the tungsten if required.
- **Loose connection:** Check all connectors and tighten.
- **Earth clamp not connected to work:** Connect the earth clamp directly to the workpiece wherever possible.

STICK (MMA) TROUBLESHOOTING

1. No arc

- **Incomplete welding circuit:** Check earth lead is connected. Check all cable connections.
- **Wrong mode selected:** Check the MMA selector switch is selected.
- **No power supply:** Check that the machine is switched on and has a power supply.

2. Porosity - Small cavities or holes resulting from gas pockets in weld metal

- **Arc length too long:** Shorten the arc length.
- **Work piece dirty, contaminated or moisture:** Remove moisture and materials like paint, grease, oil, and dirt, including mill scale, from base metal.
- **Damp electrodes:** Use only dry electrodes.

3. Excessive Spatter

- **Amperage too high:** Decrease the amperage or choose a larger electrode.
- **Arc length too long:** Shorten the arc length.

4. Weld sits on top, lack of fusion

- **Insufficient heat input:** Increase the amperage or choose a larger electrode.
- **Work piece dirty, contaminated or moisture:** Remove moisture and materials like paint, grease, oil, and dirt, including mill scale, from base metal.
- **Poor welding technique:** Use the correct welding technique or seek assistance for the correct technique.

5. Lack of penetration

- **Insufficient heat input:** Increase the amperage or choose a larger electrode.
- **Poor welding technique:** Use the correct welding technique or seek assistance for the correct technique.
- **Poor joint preparation:** Check the joint design and fit up, make sure the material is not too thick. Seek assistance for the correct joint design and fit up.

6. Excessive penetration - Burn through

- **Excessive heat input:** Reduce the amperage or use a smaller electrode.
- **Incorrect travel speed:** Try increasing the weld travel speed.

7. Uneven weld appearance

- **Unsteady hand, wavering hand:** Use two hands where possible to steady up, practise your technique.

8. Distortion - Movement of base metal during welding

- **Excessive heat input:** Reduce the amperage or use a smaller electrode.
- **Poor welding technique:** Use the correct welding technique or seek assistance for the correct technique.
- **Poor joint preparation and or joint design:** Check the joint design and fit up, make sure the material is not too thick. Seek assistance for the correct joint design and fit up.

9. Electrode welds with different or unusual arc characteristic

- **Incorrect polarity:** Change the polarity, check the electrode manufacturer for correct polarity.

ERROR CODE LIST

Error Code	Error	Recommended action	Possible Cause
E01	Over Temperature!	<ul style="list-style-type: none"> Let the machine cool itself down. Do not turn off the machine, it requires the fans to keep running to effectively cool the machine. 	<ul style="list-style-type: none"> High temperature Duty cycle reached
E02	Over Temperature!	<ul style="list-style-type: none"> Let the machine cool itself down. Do not turn off the machine, it requires the fans to keep running to effectively cool the machine. 	<ul style="list-style-type: none"> High temperature Duty cycle reached
E09	Over Time Of Continusly Welding!	<ul style="list-style-type: none"> Let the machine cool itself down. Do not turn off the machine, it requires the fans to keep running to effectively cool the machine. 	<ul style="list-style-type: none"> High temperature Duty cycle reached
E13	Low Input Power	<ul style="list-style-type: none"> Power outlet may be too low, try another outlet. If using an extension cord, ensure cord has at least 2.5mm² copper diameter. 	<ul style="list-style-type: none"> Input power is too low
E41	Communication Error!	<ul style="list-style-type: none"> Contact UNIMIG Service Department. 	<ul style="list-style-type: none"> Communication between the LCD screen and PCB boards may be damaged
E50	Flash Error!	<ul style="list-style-type: none"> Contact UNIMIG Service Department. 	
E60	Thermistor Unplugged Error	<ul style="list-style-type: none"> Contact UNIMIG Service Department. 	



HEAD OFFICE:

112 Christina Rd,
Villawood NSW 2163

PH: (02) 9780 4200
FAX: (02) 9780 4210

EMAIL: sales@unimig.com.au

QLD OFFICE:

19 Commerce Cct,
Yatala QLD 4207

PH: (07) 3333 2855
FAX: (07) 3274 5829

EMAIL: qld@unimig.com.au

VIC OFFICE:

91 Yellowbox Drive,
Craigieburn VIC 3064

PH: (03) 8682 9911
FAX: (03) 9333 7867

EMAIL: vicsales@unimig.com.au

WA OFFICE:

26 Sustainable Ave,
Bibra Lake WA 6163

PH: (08) 6363 5111
FAX: (08) 9417 4781

EMAIL: wasales@unimig.com.au